

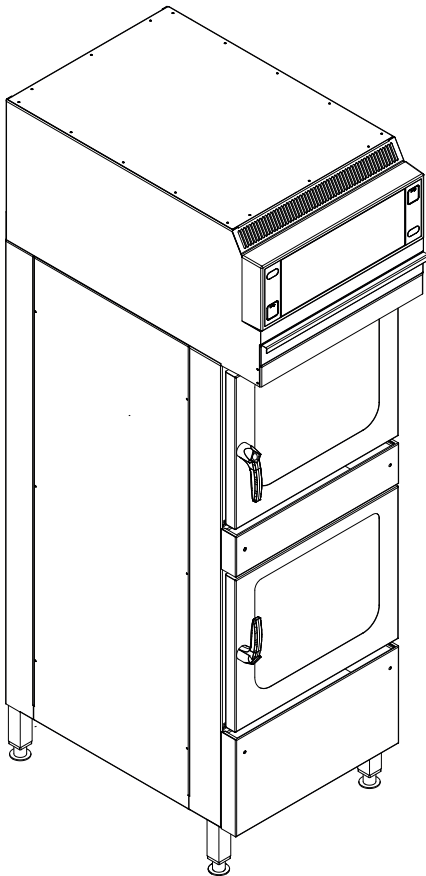

Read the operating instructions prior to commissioning

FlexFusion® ELECTRIC SPACE\$AVER (PLUS) TEAM



Operation Manual

Model

FSDE 610.610

FM 05-256-A • 9/17/2018



FM 05-256-A

en-US

Operating and display elements

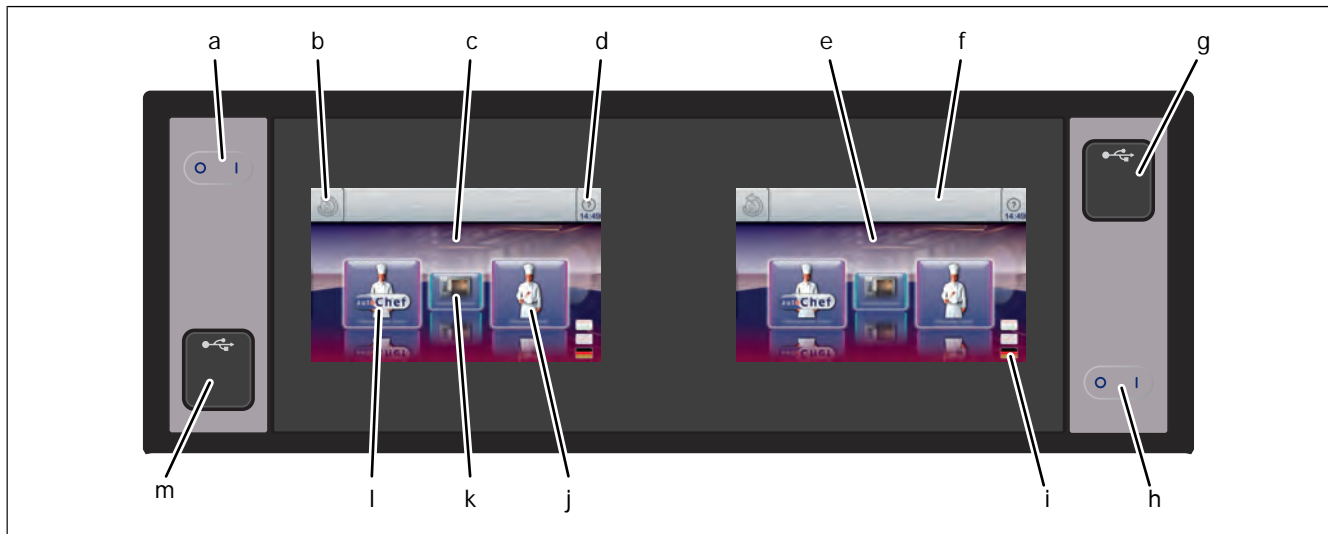

- | | | | |
|---|---|---|--|
| a | <i>On Off "I O" button for top unit</i> | h | <i>On Off "I O" button for bottom unit</i> |
| b | <i>Back button</i> | i | <i>Language selection button</i> |
| c | <i>Operating element with touchscreen for top unit</i> | j | <i>"Manual cooking" button</i> |
| d | <i>FlexiHelp button</i> | k | <i>"Unit functions" button</i> |
| e | <i>Operating element with touchscreen for bottom unit</i> | l | <i>"Automatic cooking" button</i> |
| f | <i>Information strip</i> | m | <i>USB port for top unit</i> |
| g | <i>USB port for bottom unit</i> | | |



Henny Penny Corporation
P.O.Box 60
Eaton, OH 45320
USA

Phone +1 937 456-8400
Fax +1 937 456-8402

Toll free in USA
Phone +1 937 417-8417
Fax +1 937 417-8434

www.hennypenny.com



1 Introduction	9
1.1 About this manual	9
1.1.1 Explanation of signs	10
1.2 Intended use	11
1.3 Warranty	11
2 Safety instructions	12
3 Description of the unit	15
3.1 Overview of the unit	15
3.2 Features	16
3.2.1 Characteristics	16
3.2.2 HACCP logging	17
3.2.3 VideoAssist	17
3.2.4 WaveClean automatic cleaning	17
3.3 Operating and cooking modes	17
3.3.1 Operating modes	17
3.3.2 Cooking modes	18
3.3.3 Expanded cooking functions	19
3.3.4 Core temp. measurement	21
3.4 Chef's Touch unit controls	22
3.4.1 Touchscreen operation	23
3.4.2 Operating, control and display element functions	25
3.4.3 Display elements	25
3.5 Loading capacities	27
3.5.1 Plate capacity during regeneration	27
3.6 Standard settings	27
3.6.1 Temperature standard setting	27
3.6.2 Core temperature standard setting	28
3.6.3 Cooking chamber humidity standard setting	28
4 Quick introduction	29
5 Operating the unit	30
5.1 Environmentally friendly operation	30
5.2 Switching the unit on and off	30
5.2.1 Switching on	30
5.2.2 Switching off	30
5.3 Opening and closing the cooking chamber door	30
5.3.1 Opening	30
5.3.2 Closing	31
5.4 Loading and emptying the unit	31
5.4.1 Loading	31
5.4.2 Emptying	32
5.5 Unit functions menu	32

5.5.1 Accessing the main menu	32
5.5.2 Opening the Unit functions menu	33
5.5.3 Changing the basic settings	33
5.5.4 Retrieving unit information	35
5.5.5 Setting the date and time	35
5.5.6 Presetting the language selection	36
5.5.7 Setting favorites	37
5.5.8 Activating and canceling inhibit operation	37
5.5.9 Setting the background lighting	38
5.5.10 Setting the water filter maintenance	38
5.5.11 Possible settings in the parameter level	39
5.5.12 Importing video	40
5.5.13 Importing images	41
5.5.14 Importing recipes	41
5.6 Basic functions	42
5.6.1 Setting the cooking temperature	42
5.6.2 Setting the cooking time and continuous operation	44
5.6.3 Using start time selection	46
5.6.4 Setting the core temperature	47
5.6.5 Setting the fan speed and direction of rotation	49
5.6.6 Using Perfection (regeneration)	50
5.6.7 Using PerfectHold	51
5.6.8 Ready2CookSetting	52
5.6.9 Steam Exhaust SystemUsing the (SES)	52
5.6.10 RackControlUsing 2	53
5.6.11 Time2ServeSetting	56
5.6.12 FamilyMixUsing	57
5.6.13 Using continue cooking	58
5.6.14 Setting manual steaming	59
5.6.15 Setting a resting step	60
5.6.16 QualityControlUsing	61
5.6.17 Using LT cooking	62
5.6.18 Using the barcode scanner	63
5.6.19 Inserting and removing the USB stick	63
5.6.20 Preparing a USB stick for importing and exporting	64
5.6.21 Exporting the HACCP log	64
5.7 Using the core temperature sensor	65
5.7.1 Measuring with a 4-point core temperature sensor	65
5.7.2 Measuring the core temperature when cooking frozen food	66
5.7.3 Core temperature display with time-controlled cooking process	66
5.7.4 Core temperature display outside the cooking process	66
5.8 Manual cooking	67
5.8.1 Opening the Manual cooking menu	67
5.8.2 Creating a cooking program step	67

5.9 Creating and managing your own cooking programs	69
5.9.1 Creating a cooking program	70
5.9.2 Saving the cooking program	71
5.9.3 Exporting a cooking program	74
5.10 Automatic cooking (autoChef)	74
5.10.1 Opening the Automatic cooking menu	75
5.10.2 Finding and opening a cooking program	75
5.10.3 Starting the cooking program	76
5.10.4 Ending the cooking program	76
5.10.5 Modifying the cooking program	77
5.10.6 Deleting a cooking program	78
5.10.7 Exporting and importing a cooking program	79
5.11 VideoAssist	80
5.11.1 Watching a video	80
5.11.2 Deleting a video	81
5.12 Pausing and ending operation	81
5.12.1 Performing a hygiene flush after an extended period of idleness	81
6 Cleaning and caring for the unit	82
6.1 Preventing corrosion	82
6.2 Removing rust spots	82
6.3 Cleaning the housing	83
6.4 Cleaning the door handle, operating elements and control panel ..	83
6.5 Cleaning the touchscreen	83
6.6 Cleaning the door seal	84
6.7 Cleaning the cooking chamber door	84
6.7.1 Cleaning the door with hygienic glazing	84
6.8 Cleaning recirculation hood	85
6.9 Cleaning the recirculation hood filter	85
6.9.1 Cleaning the yellow filter mat	86
6.9.2 Changing air filter in recirculation hood	87
6.9.3 Cleaning the condensation area	87
6.9.4 Inspecting the active carbon filter	87
6.10 Removing calcium deposits from the unit	87
6.11 Cleaning the cooking chamber automatically with WaveClean	88
6.11.1 Preparing for cleaning	89
6.11.2 Selecting the cleaning level	89
6.11.3 Inserting the cleaning cartridge	90
6.11.4 Starting automatic cleaning	90
6.11.5 Canceling automatic cleaning	91
6.11.6 Ending automatic cleaning	91
6.12 Cleaning the cooking chamber manually	92

6.12.1 Preparing the cooking chamber	92
6.12.2 Starting the cleaning program	92
6.12.3 Spraying the cleaner	92
6.12.4 Allowing the cleaner to act	92
6.12.5 Starting cleaning	93
6.12.6 Drying the cooking chamber	93
6.13 Inspecting the unit	93
6.13.1 Performing a visual inspection	93
7 Troubleshooting	94
7.1 Emergency operation	94
7.2 Nameplate	94
7.3 Cause of error and remedy	94
8 Carrying out maintenance	96
9 Disposing of unit in an environmentally responsible manner	97
Keyword index	98

1 Introduction

1.1 About this manual

The operating instructions are part of the unit and contain information:

- on safe operation,
- on cleaning and care
- on remedial actions in case of faults.

Observe the following notes and adhere to them:

- Read the operating instructions completely before operating the unit for the first time.
- Make the operating instructions available to the operator at all times at the operating site of the unit.
- Insert any supplements from the manufacturer.
- Keep the operating instructions throughout the service life of the unit.
- Pass on the operating instructions to any subsequent operator of the unit.

Target group The target group of the instruction manual is the operator, who is entrusted with the operation, cleaning and care of the unit.

Figures All figures in this manual are intended as examples. Discrepancies can arise between this and the actual unit.

1.1.1 Explanation of signs

 **DANGER**

Imminent danger

Failure to comply will lead to death or very severe injuries.

 **WARNING**

Potential danger

Failure to comply can lead to death or very severe injuries.

 **CAUTION**

Dangerous situation

Failure to comply can lead do slight to moderately severe injuries.

NOTICE

Property damage

Failure to comply can cause property damage.

INFORMATION

Information

Notes for better understanding and operation of the unit.

Symbol / sign	Meaning
•	Listing of information.
→	Action steps which can be performed in any sequence.
1. 2.	Action steps which must be performed in the specified sequence.
↳	Result of an action performed or additional information relating to it.

1.2 Intended use

This unit is intended to be used solely for commercial purposes, particularly in commercial kitchens.

This unit may only be used with suitable accessories and for the cooking of food.

It is forbidden to use the unit for other purposes, which include the following:

- Washing dishes
- As set-down area in or on the unit
- Storing supplies
- Drying cloths, paper or dishes
- Heating acids, alkaline solutions or other chemicals
- Heating preserved food
- Heating combustible liquids
- Heating rooms
- Cleaning air filters

1.3 Warranty

The warranty is void and safety is no longer assured in the event of:

- Improper conversion or technical modifications of the unit,
- Improper use,
- Improper startup, operation or maintenance of the unit,
- Problems resulting from failure to observe these instructions.

2 Safety instructions

The unit complies with applicable safety standards. Residual risks associated with operation or risks resulting from incorrect operation cannot be ruled out and are mentioned specifically in the safety instructions and warnings.

The operator must be familiar with regional regulations and observe them.

Operation Persons under the age of 16 are not allowed to operate the unit.

During operation, the following group of individuals must be supervised by an individual who is responsible for safety:

- Individuals with physical, sensory, or mental handicaps, or who lack the knowledge and experience to operate the unit properly.

The supervising individual must be familiar with the unit and the risks associated with it.

Children are not allowed to operate or play with the unit.

Hot surfaces Risk of burns from hot surfaces

- Protect arms and hands by wearing suitable protective gloves.
- Allow surfaces to cool prior to cleaning.
- Remove hot utensils only with suitable protective gloves or potholders.
- Remove containers and baking sheets only with suitable protective gloves or potholders.

Hot liquids Risk of scalding from hot liquids

- Protect arms and hands by wearing suitable protective gloves.
- Remove, transport and empty containers carefully.

Risk of chemical burns from evaporating cleaners

- Follow the instructions of the cleaning agent manufacturer.
- Allow the cooking chamber to cool to a temperature below 60 °C (140°F) and then clean.

Risk of scalding from steam

- Protect arms and hands by wearing protective gloves.
- Do not hold hands in front of the extractor hood.
- First open the cooking chamber door slightly and allow the steam to escape. Then open the cooking chamber door completely.
- Dry unit completely after cleaning it.
- Only open the bottom cooking zone door, if there are no functions being carried out in the top cooking zone.

Defective unit Risk of injury from a defective unit

- Disconnect a defective unit from the electrical supply mains.
- Do not operate a defective unit.
- Allow only qualified personnel to repair the unit.

Fire prevention Risk of fire from dirt and grease deposits

- Clean the unit when finished using it.
- Do not use the unit as a deep fat fryer.
- Clean cooking chamber regularly and remove collected grease.

Risk of fire from overheating

- Do not store any combustible objects or plastic containers in the cooking chamber.

Firefighting

- In the event of a fire, disconnect the unit from the electrical supply mains.
- Use a Fire Class F fire extinguisher, never water, to extinguish grease fires. Other fires, for instance, can be extinguished with fire extinguishers suitable for Fire Classes A, B, C, CO₂ fire extinguishers or extinguishing media suitable for the fire class confronted.

Improper cleaning Risk of chemical burns from cleaning agent

- Follow the instructions of the cleaning agent manufacturer.
- Take appropriate protective measures when handling aggressive cleaning agents.

Risk of falling on smooth floors

- Keep the floor in front of the unit clean and dry.

Risk of injury from improper cleaning

- Clean the cooking chamber carefully. The cooking chamber sensor protrudes into the cooking chamber.

Risk of property damage from improper cleaning

- Clean the unit after using it.
- Do not clean the unit with a high-pressure cleaner or water jet.
- Do not clean the housing with highly abrasive or chemically aggressive cleaning agents.
- Do not clean the housing with highly abrasive sponges.
- Follow the instructions of the cleaning agent manufacturer.
- Do not shock the unit by cooling it abruptly.
- Clean the cooking chamber carefully. The cooking chamber sensor protrudes into the cooking chamber.

Safety instructions

- Do not use any bleaching or chlorine-containing cleaners or disinfectants.
- Remove rust spots with an abrasive.
- Keep the unit free of calcium deposits.

Hygiene Health risk from insufficient hygiene

- Observe applicable regional hygiene regulations.

Core temperature measurement Risk of injury from overheated core temperature sensor

- Do not heat the core temperature sensor over an open flame.

Improper use Risk of property damage from improper use

- Use only original accessories.
- Train operators regularly.
- Do not heat food warmer plates or cans of preserved food.
- Do not cover air inlet and outlet openings.
- Do not operate the unit at temperatures below 4° C (39°F).
- Remove the core temperature sensor before the cooked food is removed.
- Insert the core temperature sensor back into the holder after use.

3 Description of the unit

The unit is a hot-air steamer suitable for most cooking methods used in commercial kitchens. Selectable use of hot air, unpressurized live steam, individually, in succession or combined with moist and dry heat.

3.1 Overview of the unit

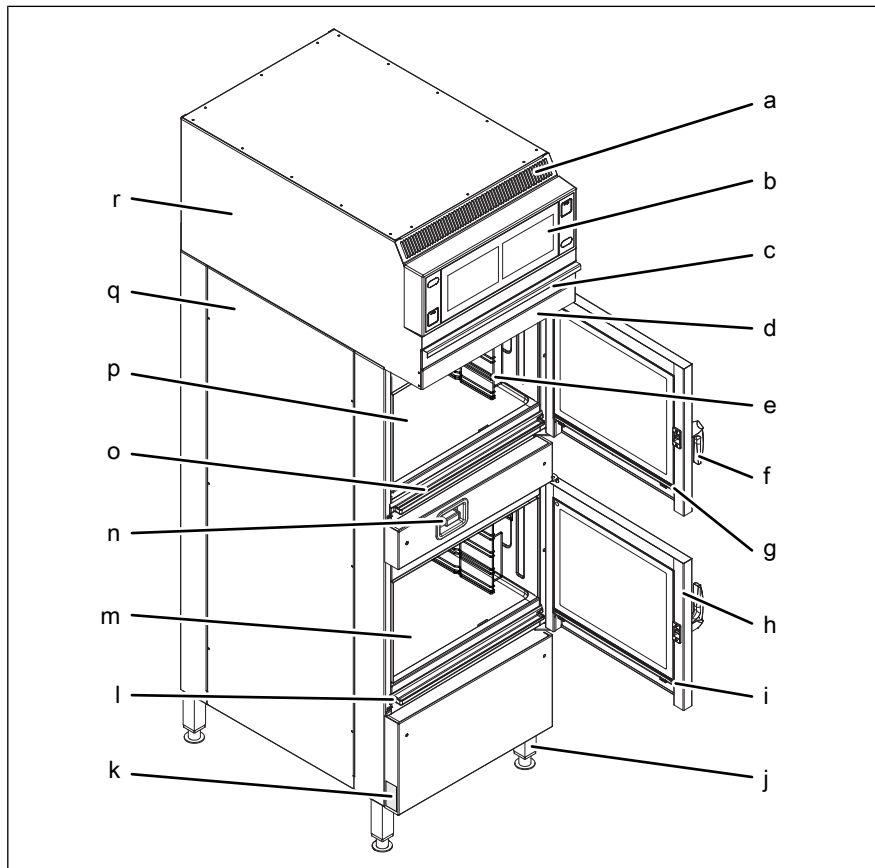

Image: Floor-standing unit

- | | | | |
|---|-----------------------------------|---|-----------------------------------|
| a | Air outlet | j | Unit leg |
| b | Operating unit | k | Nameplate |
| c | Filter drawer | l | Discharge channel for bottom unit |
| d | Condensate baffle | m | Cooking chamber in bottom unit |
| e | Hang-in frame | n | Hand shower (optional) |
| f | Door handle | o | Discharge channel for top unit |
| g | Discharge channel for top door | p | Cooking chamber in top unit |
| h | Cooking chamber door | q | Housing |
| i | Discharge channel for bottom door | r | Recirculation hood |

3.2 Features

3.2.1 Characteristics

- Cooking chamber door with hygienic glazing
- Halogen cooking zone lighting
- 4-point core temperature sensor
- 1-step door lock
- Power optimization system (optional)
- Cooking chamber door hinged at right
- Cooking chamber door hinged at left (optional)
- Barcode scanner (optional)
- USB interface
- Ethernet interface (optional)
- Hand shower (optional)

Software

- Import function for cooking programs
- Cooking program protection
- Favorites
- ChefsHelp
- QualityControl
- VideoAssist
- FamilyMix
- Time2Serve
- PerfectHold
- ClimaSelect plus
- GreenInside
- Eco mode
- PHleco DynaSteam2
- Steam Exhaust System (SES)
- Perfection
- Ready2Cook
- RackControl
- Start-time selection
- WaveClean (optional)

3.2.2 HACCP logging

All cooling programs run are recorded in the HACCP log.

The data are exported via the USB port.

3.2.3 VideoAssist

VideoAssist can be used to display videos with additional explanations regarding operation.

3.2.4 WaveClean automatic cleaning

With WaveClean automatic cleaning, the cooking chamber is cleaned with the aid of a cleaning cartridge intended specifically for the program and then rinsed clean.

3.3 Operating and cooking modes

3.3.1 Operating modes



Manual cooking

In the Manual cooking mode, individual cooking modes and equipment functions can be actuated directly. The various types of cooking and equipment functions can be adapted individually.



Automatic cooking (autoChef)

In the Automatic cooking mode, stored cooking programs can be actuated and adapted as necessary.

3.3.2 Cooking modes



Steaming

Steaming is a cooking mode in which the food to be cooked is cooked gently by means of steam in a temperature range of 30 °C (86 °F) to 130 °C (266 °F).



Combisteaming

Combisteaming is a cooking mode in which the steaming and hot air cooking modes are combined. The temperature range extends from 30 °C (86 °F) to 250 °C (482 °F).



Hot air

Hot air is a cooking mode, in which the food to be cooked is cooked without additional moisture in a temperature range of 30 °C (86 °F) to 300 °C (572 °F).



Perfection (regeneration)

Perfection is a cooking mode, in which cooled food to be cooked can be kept warm and prepared in a short time in a temperature range of 30 °C (86 °F) to 180 °C (356 °F).



Delta-T cooking

Delta-T cooking is a cooking mode where the cooking temperature depends on the core temperature of the food being cooked.



The cooking temperature is always higher than the current core temperature by the set value (Delta-T value, cooking temperature difference). The resulting cooking time is longer than with other cooking modes.



Delta-T cooking is especially well-suited for general cooking. The food being cooked remains tender and juicy with little weight loss.



Low-temperature cooking

Low-temperature cooking is a cooking mode, in which the food to be cooked is cooked particularly gently in a temperature range of 30 °C (86 °F) to 100 °C (212 °F).

The cooking time is considerably longer than at higher temperatures, but no supervision is required and the cooking time can be extended considerably without any loss in quality.

The food being cooked remains tender and juicy with little weight loss.



Baking

Baking is a cooking mode in which the texture of the food to be cooked is loosened and then cooked and browned by hot air in a temperature range of 30 °C (86 °F) to 220 °C (428 °F). Before baking takes place, a humidifying process and its associated acting time can be performed.

3.3.3 Expanded cooking functions

Expanded cooking functions can be used to adapt individual cooking steps to the particular food being cooked.

The following expanded cooking functions are available:



PerfectHold

PerfectHOLD is a cooking function, in which the food to be cooked is kept warm in the unit at a temperature range of 50 °C (122 °F) to 100 °C (212 °F) after the actual cooking process, until it is ready to be served.

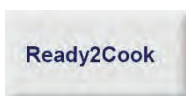

Ready2Cook (preheating)

For many cooking programs such as baking, for instance, the correct starting temperature is important.

With Ready2Cook, the cooking chamber can automatically be heated or cooled to the correct starting temperature.

A screen-filling display gives information during the procedure about the status.



Start-time selection

INFORMATION

When using start time selection, temperatures that promote the growth of harmful microorganisms on the food being cooked can occur in the cooking chamber. Observe food processing regulations.

Start time selection can be used to set a waiting period until the program starts.

In this way, bottlenecks in production and preparation can be avoided.

The prepared food can be loaded into the unit and the desired cooking program selected.



Steam Exhaust System (SES)

This function is activated by default for all cooking programs that have a cooking time longer than 6 minutes.

The Steam Exhaust System (SES) is activated automatically shortly before the end of cooking.

After the cooking time, the Steam Exhaust System (SES) extracts the steam from the cooking chamber. It is then possible to open the cooking chamber door without risk of injury.



RackControl2

RackControl is ideal for rolling cooking.

With the extended RackControl2 cooking function, different foods such as potatoes, cauliflower, peas, carrots and meat can be cooked simultaneously for different times.

RackControl2 monitors the various cooking times in one process. When one cooking time has elapsed, a signal sounds and the food being cooked can be removed.

The set temperature can be changed during an active cooking process, without the process having to be stopped.



ChefsHelp

With the ChefsHelp advanced cooking program, it is possible to insert a cooking step that assists the user further with Information in the form of text and images at a certain time.



FamilyMix

With the expanded cooking function FamilyMix, the appropriate cooking programs are displayed in the *Automatic cooking (autoChef)* menu for the currently set cooking mode. The cooking programs displayed have the same cooking climate and an identical or shorter cooking time. Tapping the individual suggestions transfers the cooking times for the individual products to the RackControl function and these can then be started when desired during the cooking process.



Manual steaming

Manual steaming allows the cooking chamber humidity to be increased during operation.

Manual steaming can only be used in the Hot air and Delta T hot air cooking modes.

The remaining time for this procedure is displayed during steaming. After the Drop symbol has been touched, the set value is displayed for 3 seconds.



Idle time

With the idle time expanded cooking function, a cooking step can be inserted during which the heating and the fans are programmed to switch off for a certain period of time.



QualityControl

With the expanded QualityControl cooking function, the control senses the amount loaded automatically and adjusts the individual cooking parameters in autoChef. This ensures first-class quality consistently.

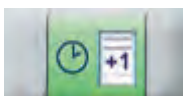

Continue cooking button

The Continue cooking button lets you continue the cooking process for a predefined period of time after the cooking program has ended.

DynaSteam²

The DynaSteam² function is used to match the required amount of steam to the product volume of the food being cooked. The steam is finely adjusted and automatically introduced into the cooking chamber.

Time2Serve

With the Time2Serve advanced cooking function, different products are ready to be served at the same time.

The serving time is specified. The combi-steamer signals when it has reached a remaining cooking time for a product. A signal sounds and the food to be cooked is loaded successively during an active cooking process. The cooking time is shortened, conserving resources.

**ClimaSelect plus**

The ClimaSelect plus advanced cooking function optimizes the atmosphere in the cooking chamber. Steam is added in small amounts; the atmosphere can be controlled individually.

3.3.4 Core temp. measurement

When using core temperature measurement, the temperature inside the food being cooked is measured by means of a core temperature sensor.

As soon as the target core temperature is reached, the cooking process is ended automatically or, in the case of a multi-step cooking program, the next cooking step starts.

The use of core temperature measurement offers the following benefits:

- Reduced energy and water consumption
- No overcooking
- Less weight lost by the food being cooked
- High HACCP safety

3.4 Chef's Touch unit controls

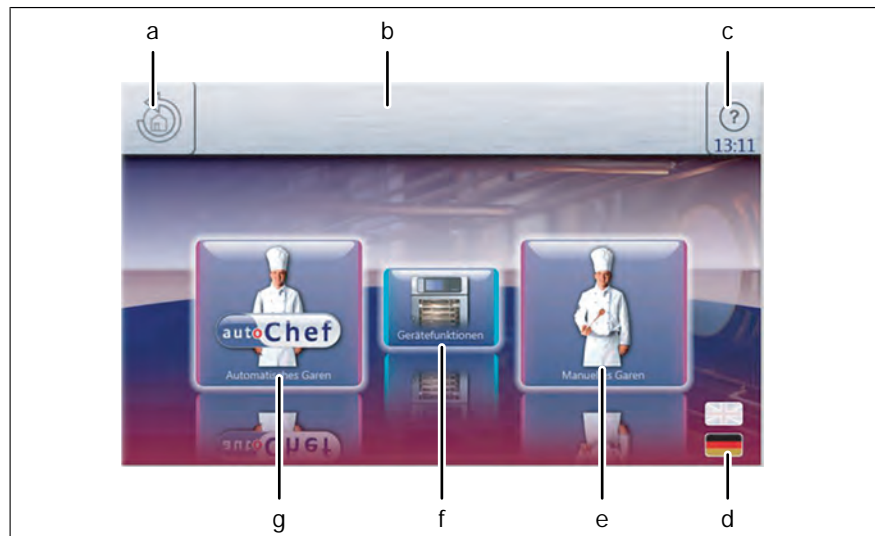

Image: Main menu

- | | |
|------------------------------------|------------------------------|
| a <i>Back</i> button | e "Manual cooking" button |
| b Information strip | f "Unit functions" button |
| c <i>Help</i> button | g "Automatic cooking" button |
| d <i>Language selection</i> button | |

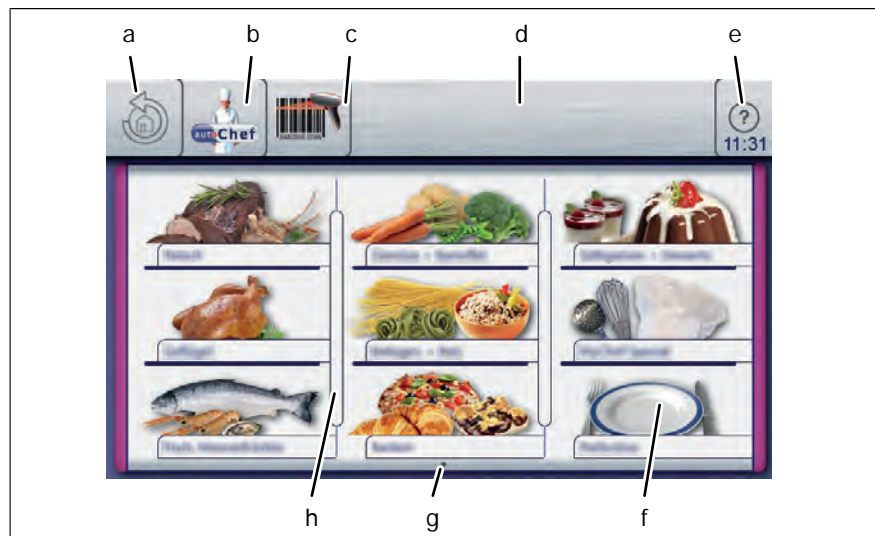

Image: Automatic cooking menu, autoChef

- | | |
|---------------------------------|---------------------------------|
| a <i>Back</i> button | e <i>Help</i> button |
| b "autoChef" button | f <i>Category</i> field |
| c <i>Barcode scanner</i> button | g <i>Next page</i> arrow symbol |
| d Information strip | h <i>Separating bar</i> |

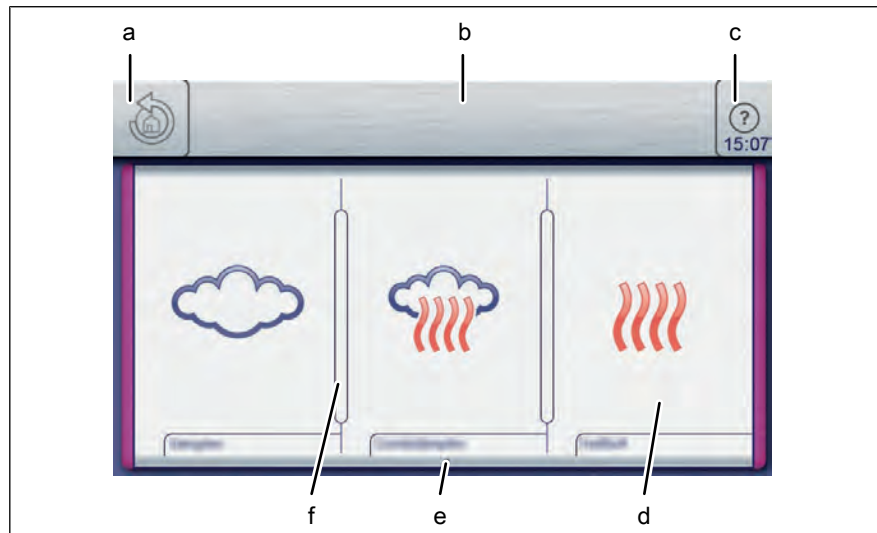

Image: Manual cooking menu

- | | | | |
|---|-------------------|---|------------------------|
| a | Back button | d | "Hot air" field |
| b | Information strip | e | Next page arrow symbol |
| c | Help button | f | Separating bar |

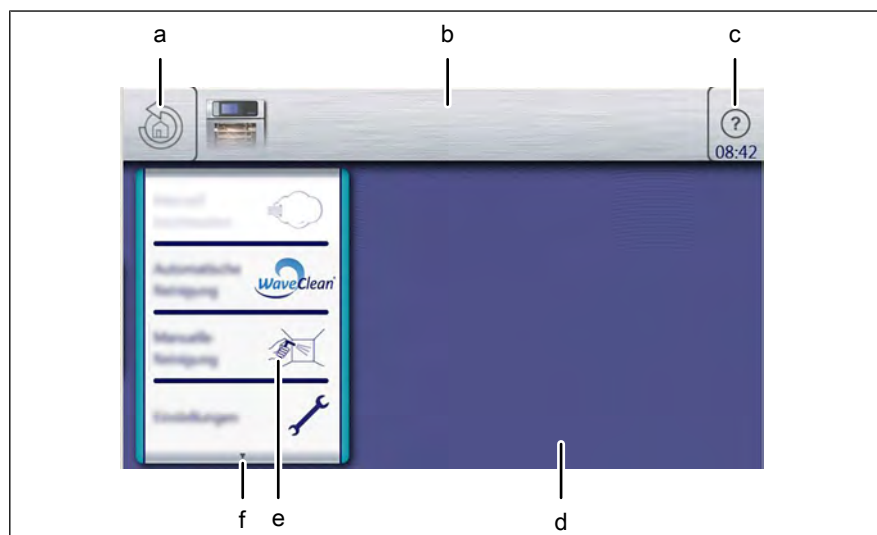

Image: Unit functions menu

- | | | | |
|---|-------------------|---|------------------------|
| a | Back button | d | Window |
| b | Information strip | e | Manual cleaning field |
| c | Help button | f | Next page arrow symbol |

3.4.1 Touchscreen operation

INFORMATION

The touchscreen can be operated with latex gloves.

Tapping

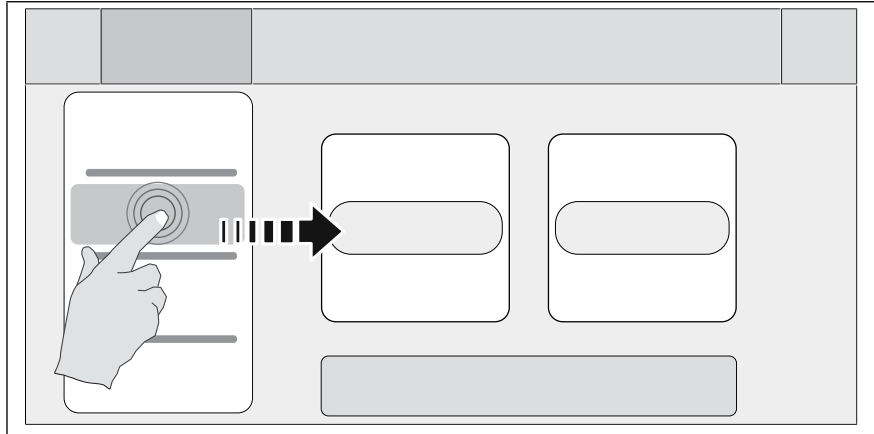

Display elements such as buttons, fields or tabs are selected or activated by tapping them. They appear to the right of the currently displayed roller.

Scrolling

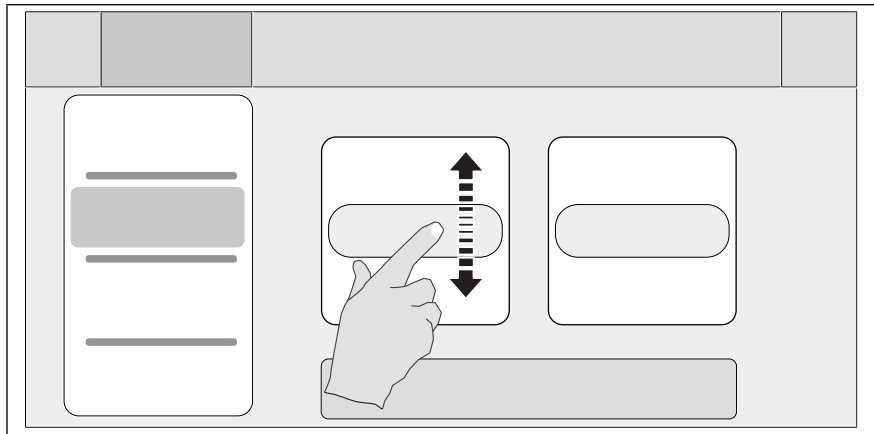





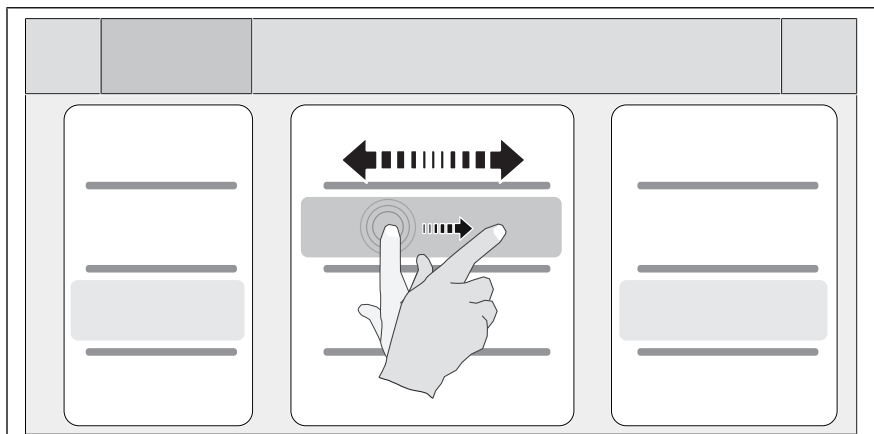

The rollers are used to scroll up or down to display additional content.

Swiping

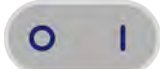

You use the swipe gesture to access fields to the right and left of the current display.

3.4.2 Operating, control and display element functions



Symbol	Operating and display element	Function
	On Off "I O" button	<ul style="list-style-type: none"> "I" switches on the unit "O" switches off the unit
	"Automatic cooking" button	<ul style="list-style-type: none"> Opens the <i>Automatic cooking</i> menu for selection of programs
	"Manual cooking" button	<ul style="list-style-type: none"> Opens the <i>Manual cooking</i> menu for selection of cooking modes
	"Unit functions" button	<ul style="list-style-type: none"> Opens the <i>Unit function</i> menu for selection of cleaning and settings
	Language selection button	<ul style="list-style-type: none"> Indicates that the operating language for the unit can be selected here by tapping a national flag <p>The selection and number of selectable languages can be specified in the <i>Unit functions</i> menu in the "Language" settings field.</p>
	Back button	<ul style="list-style-type: none"> Tapping once returns the user to the previous menu Tapping twice returns the user directly to the main menu
	Help button	<ul style="list-style-type: none"> Displays the help texts for the active menu or window.



3.4.3 Display elements

The following table lists the basic display elements of the unit's control system with examples.

Symbol	Display element	Function
	Information strip	<p>The information strip is the uppermost bar on the touchscreen and visible at all times.</p> <p>The information bar is used to display current information; for instance, categories or cooking programs.</p>

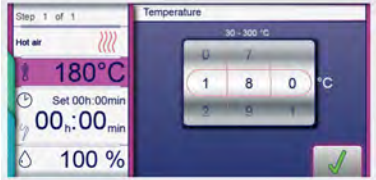
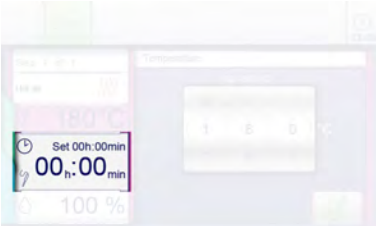
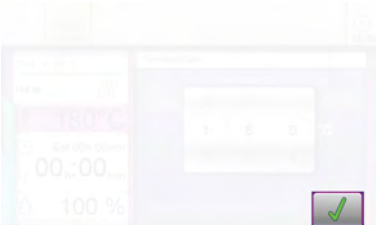
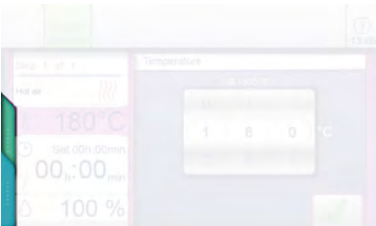
Description of the unit

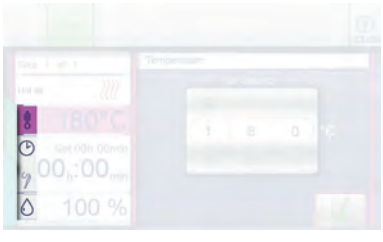
Symbol	Display element	Function
	Menu	<p>Menus have a colored border that identifies the associated subject.</p> <ul style="list-style-type: none"> • Blue for equipment functions. <p>and</p> <ul style="list-style-type: none"> • Violet for cooking functions. <p>Menus frequently contain vertical separating bars to simplify wiping gestures.</p> <p>Menus represent central entry points and provide an overview of the selectable functions and submenus.</p>
	Page	<p>Pages are the areas with content in windows and menus. Several pages can follow one another in sequence.</p> <p>An arrow symbol displays further pages. Changing to the next or the previous page is accomplished by swiping up or down.</p>
	Window	<p>Windows have a colored border and are opened from menus or higher-level windows.</p> <p>Functions are executed and settings displayed in windows.</p> <p>Depending on the function, there are several window types, for instance, Find.</p>
	Field	<p>Fields are areas in windows or menus defined by separating bars.</p> <p>Tapping fields opens functions and settings.</p>
	Button	<p>Buttons are areas enclosed by borders in windows or menus.</p> <p>Tapping buttons confirms settings. Buttons control functions and are used to navigate in menus and windows.</p>
	Tab	<p>The <i>Blue</i> tab and <i>Green</i> tab are located on the left side of the touchscreen. The tabs are only available in the Cooking steps display.</p> <p>Tapping the tabs offers quick access to unit functions and cooking program functions.</p>

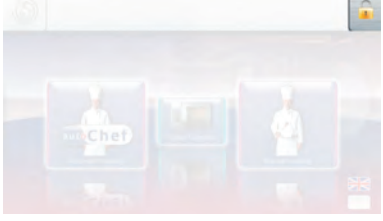
Symbol	Display element	Function
	Display	Displays are information-containing areas in windows. Displays show entries and current information some of which may be operated by tapping.
	Symbol	Symbols are graphical elements in windows and in the toolbar. Symbols indicate current states and possible functions some of which may be operated by tapping.
	Roller	Rollers are areas where settings can be made by means of swipe gestures.
	Lock	This symbol indicates that screen lock has been activated. Only the lock symbol is active. If the operator taps on the lock symbol, a numeric keypad appears. The touchscreen is unlocked by entering a specific combination of numbers.

3.5 Loading capacities

3.5.1 Plate capacity during regeneration

Cooking time and cooking temperature depend on the number of plates.

Version	Plate diameter
	26 - 32 cm
6.10	12

3.6 Standard settings

3.6.1 Temperature standard setting

The adjustment range for the cooking chamber temperature depends on the cooking mode .

Cooking mode	Standard value (°C (°F))	Setting range (°C (°F))	Change increments (°C (°F))
Steaming	100 (212)	30 (86) - 130 (266)	1 (33,8)
Combisteaming	150 (302)	30 (86) - 250 (482)	1 (33,8)
Hot air	180 (356)	30 (86) - 300 (572)	1 (33,8)
Regeneration	50 (122)	30 (86) - 180 (356)	1 (33,8)

3.6.2 Core temperature standard setting

The adjustment range for the core temperature depends on the cooking mode.

Cooking mode	Standard value (°C (°F))	Setting range (°C (°F))	Change increments (°C (°F))
Steaming	70 (158)	0 (32) - 99 (210,2)	1 (33,8)
Combisteaming	70 (158)	0 (32) - 99 (210,2)	1 (33,8)
Hot air	70 (158)	0 (32) - 99 (210,2)	1 (33,8)
Regeneration	50 (122)	0 (32) - 99 (210,2)	1 (33,8)

3.6.3 Cooking chamber humidity standard setting

Cooking chamber humidity setting range depends on the cooking mode.

Cooking mode	Standard value (%)	Setting range (%)	Change increments (%)
Steaming	100	90 - 110	90 - 100 - 110
Combisteaming	90	20 - 100	20 - 40 - 70 - 90 - 100
Hot air	100	0 - 100	0 - 25 - 50 - 75 - 100
Regeneration	100	0 - 100	0 - 25 - 50 - 75 - 100

4 Quick introduction

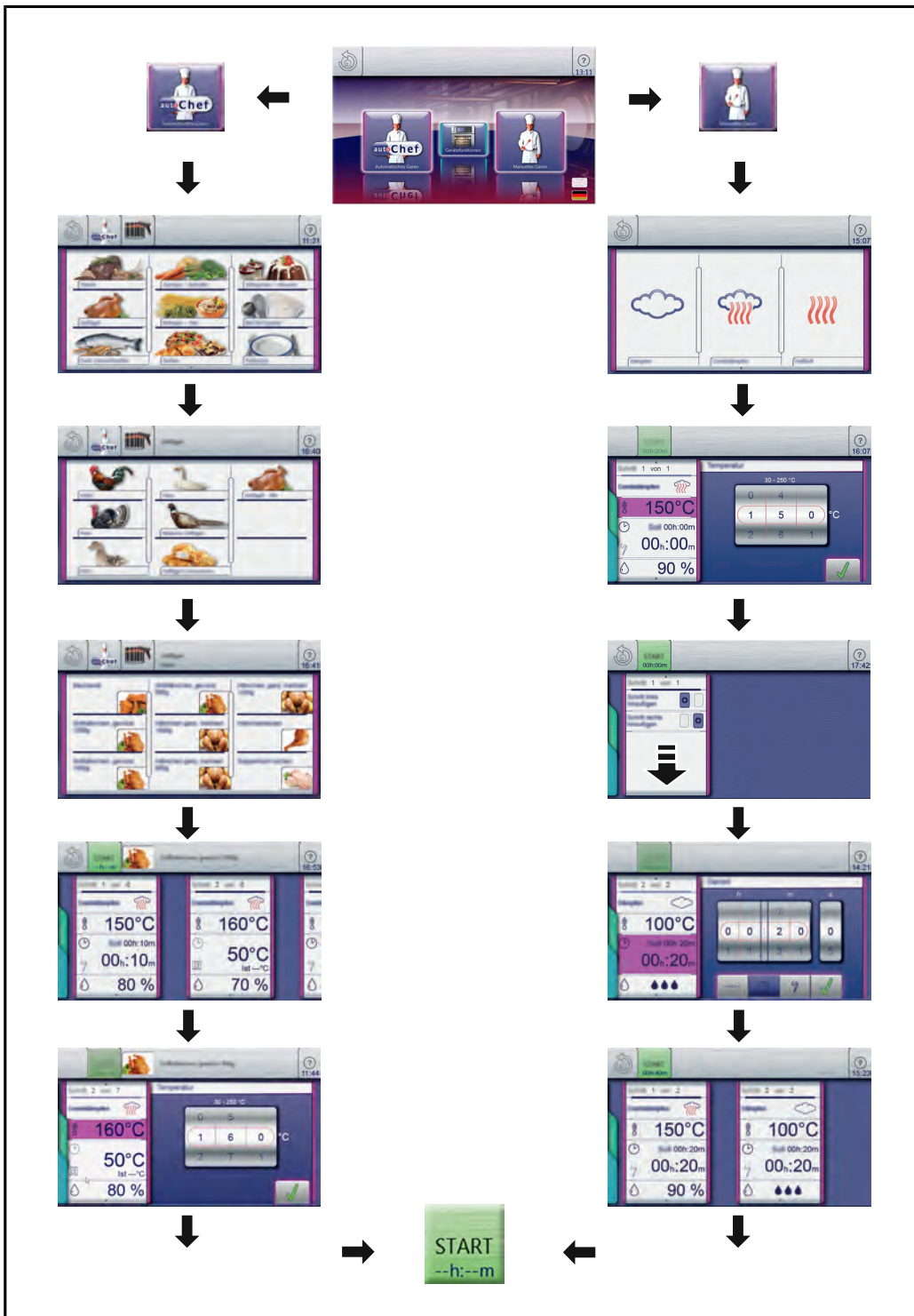

FM 05-256-A

5 Operating the unit

INFORMATION

Explanatory video clips can be selected under VideoAssist by press the Help button.

5.1 Environmentally friendly operation

When used properly, this combisteamer has very low energy consumption.

Reduce the energy consumption in the following manner:

- Avoid continuous operation - the combisteamer heats up very quickly so that continuous operation is not necessary.
- Use the full capacity of the cooking chamber - if necessary, use a combisteamer with a smaller cooking chamber.

5.2 Switching the unit on and off

5.2.1 Switching on

→ Press the *On Off "I O"* button to "I".

↳ The unit is now on.

↳ The control system starts the power-on process automatically. The progress bar at the lower edge of the touchscreen displays the status of the process.

↳ The main menu appears after 1 minute and the unit is ready for use.

5.2.2 Switching off

INFORMATION

Fans may continue to run for cooling; the unit's control system is disconnected from power.

→ Press the *On Off "I O"* button to "O".

↳ The unit is now off.

5.3 Opening and closing the cooking chamber door

5.3.1 Opening

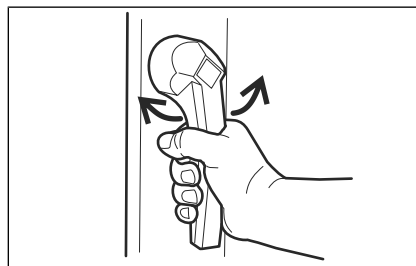
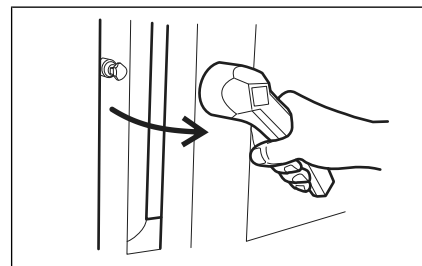

Image: Opening the 1-step door lock



1. Rotate the door handle counterclockwise or clockwise.
↳ The cooking chamber door opens.

INFORMATION

If the door handle is released, it returns automatically to its initial position.

2. Open the cooking chamber door completely.

5.3.2 Closing

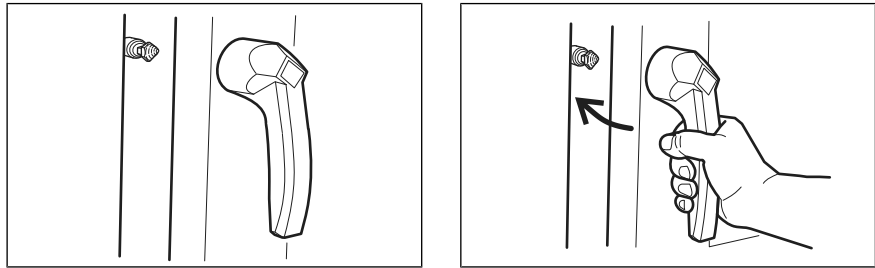

Image: Closing the 1-step door lock

Prerequisite Door handle in initial position

- Close the cooking chamber door with pressure.
↳ The cooking chamber door is closed.

5.4 Loading and emptying the unit

⚠ CAUTION

Risk of scalding from hot liquid

- Never insert a food-containing tray with cooking liquid above eye level.
- Use only suitable trays to hold food. The food-containing trays must rest securely on the support brackets.
- Always insert the food-containing trays into the U-rails.

⚠ CAUTION

Risk of property damage and personnel injury from exceeding the loading capacity

- Do not exceed the maximum loading capacity.

INFORMATION

To not use bent or damaged hang-in frame.

5.4.1 Loading

1. Open cooking chamber door.
2. Insert food-containing trays into the hang-in frame.
3. Close the cooking chamber door.

4. Start the cooking process.

5.4.2 Emptying

1. Open cooking chamber door.
2. Remove the food-containing trays.
3. Remove all leftover foodstuff from the drainage sieve.
4. Leave the cooking chamber door slightly ajar.
 - ↳ This extends the service life of the door seal.
 - ↳ No moisture builds up in the cooking chamber.

5.5 Unit functions menu

Various functions or settings can be selected in the "Unit functions" menu.

INFORMATION

All unit functions can also be accessed from within a cooking program by tapping the *blue* tab.

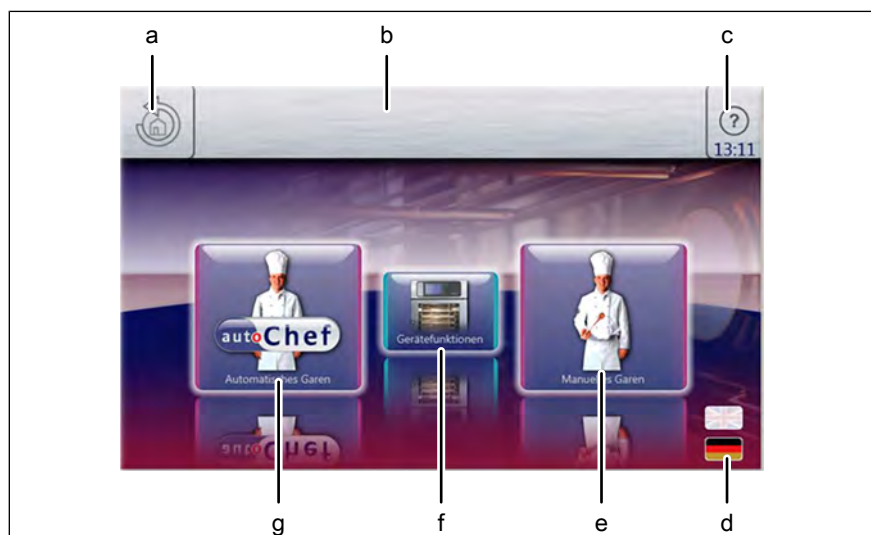

Image: Main menu

- | | | | |
|---|---------------------------|---|----------------------------|
| a | Back button | e | "Manual cooking" button |
| b | Information strip | f | "Unit functions" button |
| c | Help button | g | "Automatic cooking" button |
| d | Language selection button | | |

INFORMATION

The equipment information is displayed without entering a password.

5.5.1 Accessing the main menu

INFORMATION

The main menu can be accessed directly from every program step.

Prerequisite Open the *Cooling program* or *Settings* menu



1. Tap the *Back* button.
 - ↳ The previous menu or program step is displayed.
2. Repeat as many times as necessary.
3. Tap the *Back* button twice.
 - ↳ All program steps are skipped over.
 - ↳ The main menu appears on the display.

5.5.2 Opening the Unit functions menu

Prerequisite Unit is on
The Main menu is displayed

- Tap the "Unit functions" button.
- ↳ The *Unit functions* menu is displayed.

5.5.3 Changing the basic settings

INFORMATION

The basic settings for operation can be displayed, changed and exported by entering the password "111".

Calling up the Setting menu

Requirements *Unit functions* menu open

1. Tap the "Settings" field.
 - ↳ The *PIN* window opens.



2. Enter the password.
3. Tap the *Confirm* button.
 - ↳ The *Unit settings* menu is displayed.
 - ↳ The basic settings can be changed.

In addition to those described in this chapter, there are the following further functions.

Audio settings

Selection of the volume of the signal tones.

Operation lock

Various settings as to whether and when operation lock is to be activated.

Entering and changing the code word.

Standby mode

Deactivate the operation inhibit to set the standby mode.

When the standby mode is active, the touchscreen goes dark after a set time. The cooking chamber light switches off.

Setting the background lighting

This setting is used to reduce the brightness of the touchscreen.

Delete user's own cooking programs

Delete all the cooking programs created by the user.

Setting units

Set the units for temperature and liquid quantities.

The possibilities for temperature are °C and °F.

The possibilities for volume are mL, fl.oz (Imp.) and fl.oz (US)

Display the error memory

Retrieve stored faults for forwarding to service partners.

Import HansDampf programs

Import existing HansDampf programs.

Importing manufacturer's cookbook

Import the cookbooks provided by the manufacturer.

Select cookbook

Select the cookbooks typical of the country.

Cookbook lock

Lock function for the cooking programs in autoChef.

Setting	Function
Unlocked	Deleting, changing and overwriting the cooking programs is possible
Disabled	Changes in the cooking steps, for example temperature increases, are possible. The preset values apply again the next time the cooking program is selected.

Setting	Function
Fully locked	The cooking program can only be used in the way it has been stored. Changes in the cooking steps are not possible.

Exporting log data

Export of log data for forwarding to the service technician.

Load OEM settings

Special settings can be loaded.

Eco display on or off

Set the Eco display function.

Select signal tones

Selection of one of the four possible signal tones.

Software update

Update of the software via a USB flash drive.

Import additional content

Import of additional content via a USB flash drive.

5.5.4 Retrieving unit information

INFORMATION

The unit information contains data on the software and hardware version, the serial number of the unit and contact data.

Prerequisite The *Setting* menu is displayed



→ Tap the "Unit information" field.

↳ The *Unit information* window is displayed.

↳ Unit information can now be read.

5.5.5 Setting the date and time

INFORMATION

Observe the displayed date and time format carefully. If values are invalid, the entry is not accepted.

Prerequisite The *Settings* menu is displayed

1. Tap the "Set the date and time" field.

↳ The *Setting* window opens.

↳ The *Keyboard* opens.



2. Enter the date and time.
3. Tap the Confirm button.
 - ↳ The *Keyboard* closes.
 - ↳ The date and time are set.

5.5.6 Presetting the language selection

INFORMATION

A maximum of 5 languages can be specified for language selection in the main menu.

INFORMATION

Highlighted fields represent the specified languages.

Fields that are not highlighted are languages that have not been specified.

INFORMATION

The currently set language cannot be deselected.

Prerequisite The *Settings* menu is displayed

1. Tap the "Select language" field.
 - ↳ The *Languages* menu is displayed.

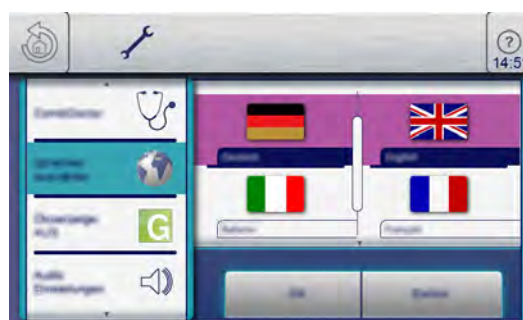

2. Select or deselect the language by tapping the fields with the country's flag.
 - ↳ The selected languages are displayed.

3. Tap the "OK" button.
- ↳ Languages have been preset for language selection and are available in the main menu.

5.5.7 Setting favorites

Which view appears on the control panel once the unit is started is selected in the *Settings for favorites*. This limits the functions that can be used by the operator.

Prerequisite *Unit functions* menu open

1. Tap the Settings for favorites field.
- ↳ The *Settings for favorites* window is displayed.

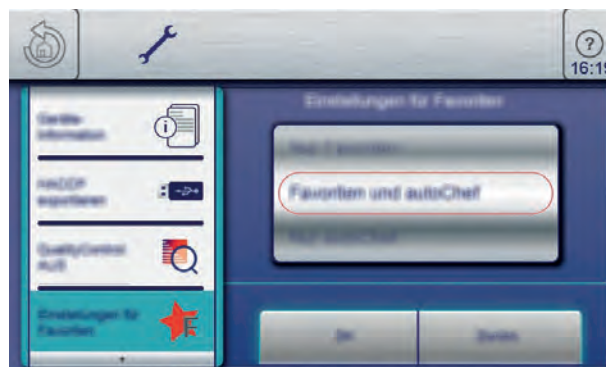

2. Using a swipe gesture, set the roller to the desired display.
 3. Tap the "OK" button.
- ↳ The Settings for favorites window closes.
- ↳ The favorites are set.

5.5.8 Activating and canceling inhibit operation

INFORMATION

The display can be locked either by tapping and holding the information bar or automatically after a specified time without touching the display. The time until the display is locked is set in the parameter level.

Activating inhibit operation

Prerequisite The "Inhibit operation ON" function is activated in the *Setting* menu

- Tap and hold the center of the information strip for 3 seconds.
- ↳ The Help button disappears and the lock symbol appears in the information strip.
- ↳ The touchscreen is locked.

Canceling inhibit operation

Prerequisite The touchscreen is locked

1. Tap the lock symbol.
↳ The Keyboard opens.



2. Enter the password.
↳ Inhibit operation is canceled by entering the password "369".
↳ The lock symbol and the keypad disappear. The *Help* button appears in the information strip and the touchscreen is unlocked.

5.5.9 Setting the background lighting

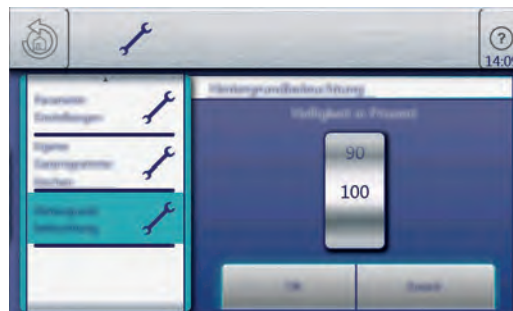

Image: Setting the brightness

Prerequisite The *Settings* menu is displayed

1. Tap the "Background lighting" field.
2. The *Brightness in percent* menu is displayed.
↳ The roller shows the current value.
3. Using a swipe gesture, set the roller to the desired value.
4. Press the "OK" button.
↳ The background lighting is set.

5.5.10 Setting the water filter maintenance

Prerequisite The *Settings* menu is displayed

1. Tap the "Water filter maintenance" field.

2. The *Water filter maintenance* menu is displayed.



- ↳ The display shows the entered date on which the reminder for the water filter maintenance is to be given.
- ↳ The filtered water quantity since the last filter change is displayed.
- ↳ The date for water filter maintenance can be entered with the keyboard and confirmed with the "OK" field.

5.5.11 Possible settings in the parameter level

Prerequisite The *Settings* menu is displayed

1. Tap the "Settings parameters" field.
 - ↳ The *Settings parameters* menu is displayed.
 2. Using a swiping gesture, set the rollers to the desired parameter.
 - ↳ The designation of the selected parameter is displayed.
 3. Tap the "Read" button.
 - ↳ The current value of the selected parameter is displayed.
 4. Delete the current value with the keyboard.
 5. Enter the new value with the keyboard.
 6. Tap the "Write" button.
 - ↳ The displayed value is adopted for this parameter.
- ↳ The parameter is changed.

Basic setting parameters

The unit is delivered with presets. The values in the following list can be modified in the parameter level.

Basic setting	Parameter s	Standard value	Range of adjustment	Explanation
Lockscreen				
Lockscreen	662	0	0 or 1	0 = Not activated, 1 = The "screen lock" field is displayed in Basic settings and can be modified.
Password	7	111	0 — 300	The password for the basic settings can be changed in this range.
Cooking modes				

FM 05-256-A

Operating the unit

Basic setting	Parameters	Standard value	Range of adjustment	Explanation
Preselected steaming temperature	9	100	30 °C (86 °F) — 130 °C (266 °F)	Preset temperature for steaming
Preset combisteam temperature	10	150	30 °C (86 °F) — 250 °C (482 °F)	Preset temperature for combisteam
Preset hot air temperature	11	180	30 °C (86 °F) — 300 °C (572 °F)	Preset temperature for hot air
Preset regeneration temperature	12	130	30 °C (86 °F) — 180 °C (356 °F)	Preset temperature for regeneration
Ready2Cook				
Ready2Cook	607	1	0 or 1	0 = Not activated, 1 = Activated
Preheating temperature Ready2Cook	4	15	0 — 30%	When loaded a full charge of large masses (roasts, loaf of bread), increase the preheat temperature so that the oven temperature does not drop too suddenly.
Cooking				
SES	624	1	0 or 1	0 = Not activated, 1 = Activated
Restart query after cooking interruption	697	2	0 — 2	0 = No query 1 = Query only with AutoChef 2 = Query always activated
Changes adopted at the end of the cooking program	696	0	0 or 1	0 = Do not adopt, 1 = Adopt
Recirculation hood				
Time extension for air recirculation hood	5	60	0 — 600 s	Condensation hood after-running time after opening the cooking chamber door

5.5.12 Importing video

Requirements WMV format

Data size < 50 MB

1. Create the directory *VideosCustom* on a USB stick.
2. Save the desired video in this directory.
↳ USB stick prepared.
3. Insert the USB stick into the MultiPort.
4. Open the *Unit functions* menu.
5. Open the *Settings* menu.
6. Select the *Import videos* menu.

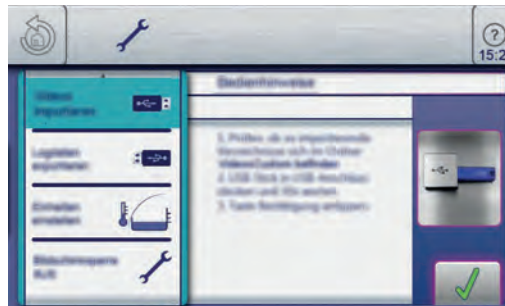

7. Follow the operating instructions.
- ↳ Video imported.

5.5.13 Importing images

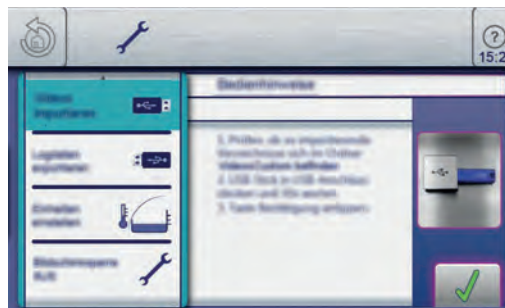

Requirements PNG format
Data size < 50 MB

1. Create the directory *autoChefImages* on a USB stick.
 2. Save the desired image in this directory.
↳ USB stick prepared.
 3. Insert the USB stick into the MultiPort.
 4. Open the *Unit function* menu.
 5. Open the *Settings* menu.
 6. Select the *Import image* menu.
 7. Follow the operating instructions.
- ↳ Image imported.

5.5.14 Importing recipes

INFORMATION

Text and graphics must be separated when converting into HTML format. For instance, in Microsoft Word the text is saved under the file type using the save filter "Web page, filtered". Before importing, make sure the file type ends with ".html".

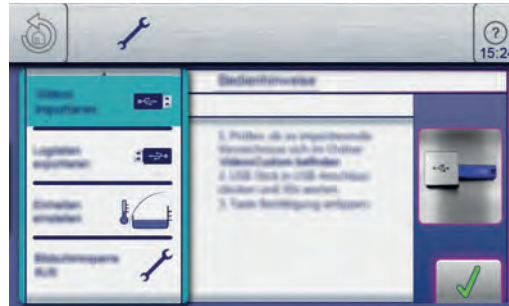

Requirements HTML format
Data size < 50 MB

1. Create the directory *FCBrowserFiles* on a USB stick.
2. Save the desired recipe in this directory.
↳ USB stick prepared.
3. Insert the USB stick into the MultiPort.
4. Open the *Unit functions* menu.
5. Open the *Settings* menu.
6. Open the *Import recipe* menu.
7. Follow the operating instructions.
↳ Recipe imported.

5.6 Basic functions

5.6.1 Setting the cooking temperature

INFORMATION

The temperature range differs, depending on the cooking mode. At a cooking temperature outside the allowed temperature range, the display turns red.

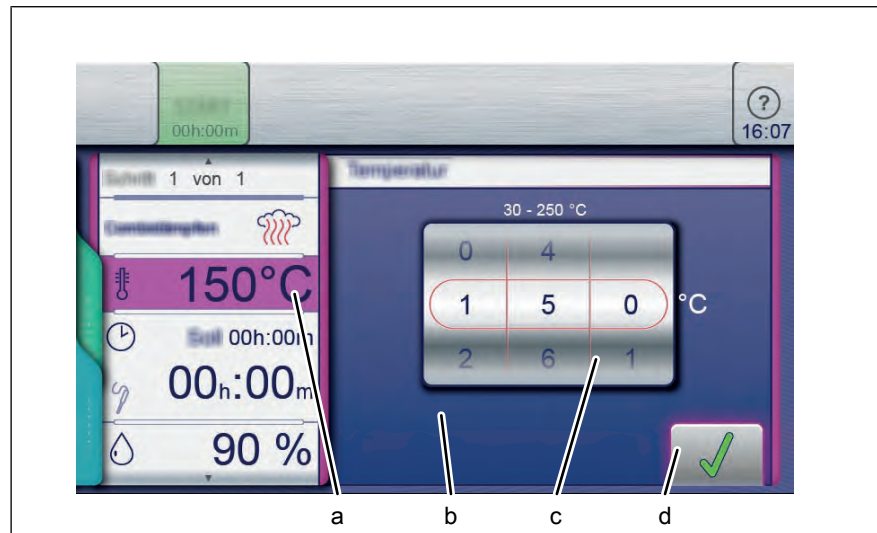

Image: Cooking temperature setting window

- | | | | |
|---|-------------------|---|----------------|
| a | Temperature field | c | Rollers |
| b | Setting window | d | Confirm button |

Prerequisite Cooking program selected

1. Tap the *Cooking temperature* field.
 - ↳ The *Setting* window is displayed.
 2. Tap the *Temperature* field.
 3. Using a swipe gesture, set the rollers to the desired temperature.
 - ↳ Swipe up / down to increase / decrease the cooking temperature.
 4. Tap the *Confirm* button.
 - ↳ The *Setting* window closes.
 - ↳ The *Cooking mode* window displays the set cooking temperature.
- ↳ The cooking temperature is set.

5.6.2 Setting the cooking time and continuous operation

Setting the cooking time

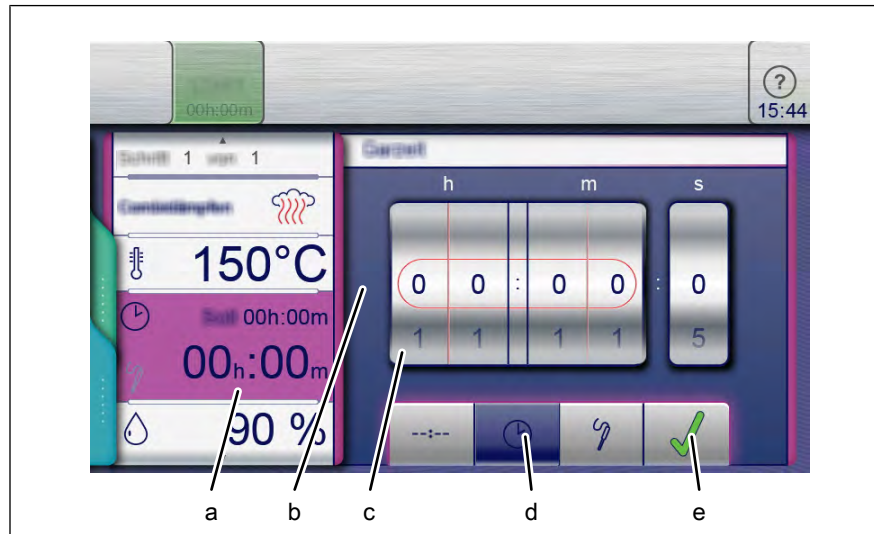

Image: Setting the cooking time

- | | | | |
|---|--------------------|---|---------------------|
| a | Cooking time field | d | Cooking time button |
| b | Setting window | e | Confirm button |
| c | Rollers | | |

Prerequisite Cooking program selected

1. Tap the *Cooking time* field.
↳ The *Setting* window is displayed.
2. Tap the *Cooking time* button.
3. Using a swipe gesture, set the rollers to the desired temperature.
↳ Swipe up / down to increase / decrease the cooking time.
4. Tap the *Confirm* button.
↳ The *Setting* window closes.
↳ The *Cooking mode* window displays the cooking time.
↳ The cooking time is set.

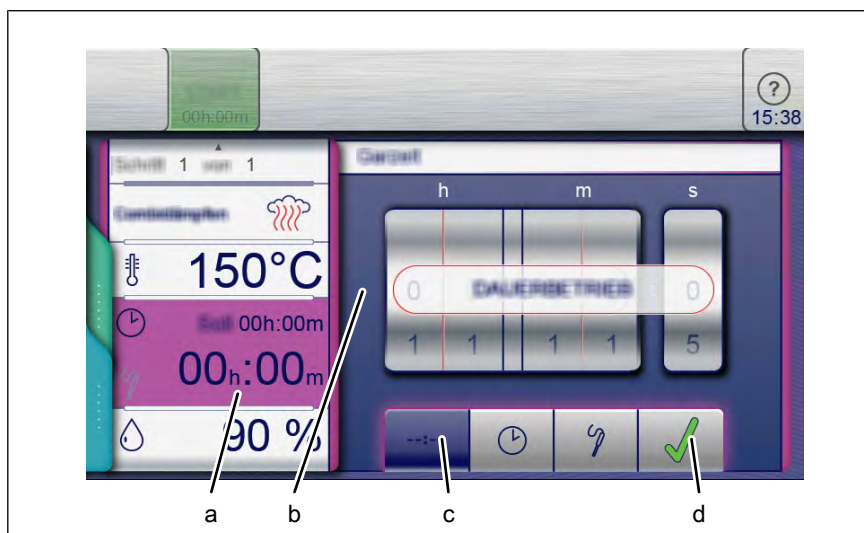

Image: Setting the cooking time to continuous operation

- | | | | |
|---|--------------------|---|-----------------------------|
| a | Cooking time field | c | Continuous operation button |
| b | Setting window | d | Confirm button |

Prerequisite Cooking program selected

1. Tap the *Cooking time* field.
 - ↳ The *Setting* window is displayed.
 2. Tap the *Continuous operation* button.
 3. Tap the *Confirm* button.
 - ↳ The *Setting* window closes.
 - ↳ The *Cooking mode* window displays the cooking time.
- ↳ The cooking time is set to continuous operation and will end after 24 hours.

INFORMATION

A cooking step which is running in continuous operation can be converted to Rest time.

5.6.3 Using start time selection

Setting the start time selection

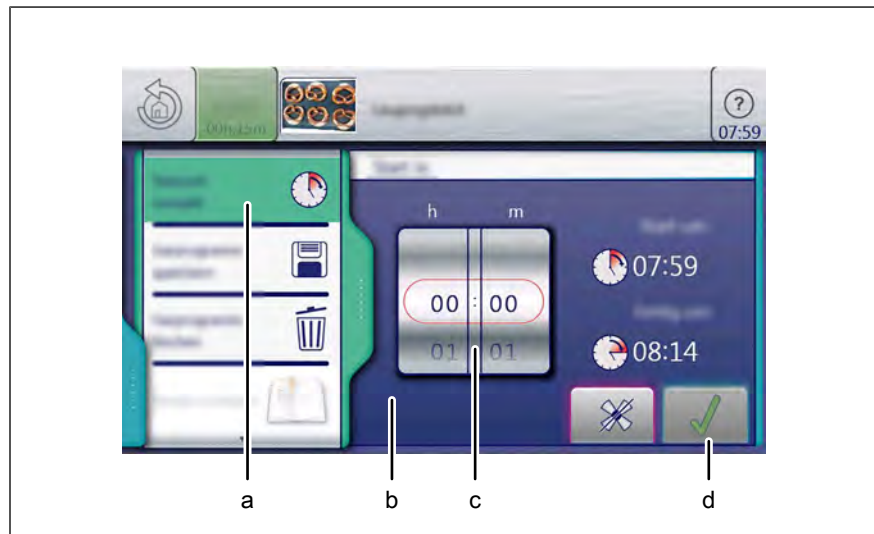

Image: Window for setting the start time selection

- | | | | |
|---|-----------------------------|---|----------------|
| a | Start time selection field | c | Rollers |
| b | Start time selection window | d | Confirm button |

Prerequisite Cooking program has ended
AutoChef automatic cooking menu open
Advanced cooking function selected

1. Tap the *Start time selection* field.
 2. Using a swipe gesture, set the rollers to the desired temperature.
 - ↳ Swipe up or down.
 - ↳ The start time is set in minutes and seconds.
 3. Tap the *Confirm* button.
 - ↳ The *Start time selection* window displays the set start time.
 - ↳ The beginning and end of the start time is displayed in real time.
- ↳ Start time selection is set for time control.

Changing the start time selection

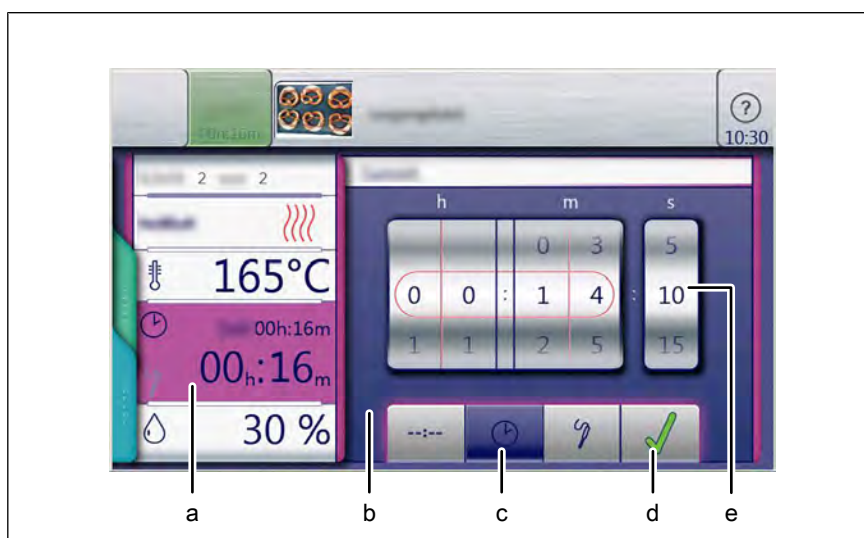

Image: Window for changing the start time setting

- | | | | |
|---|-----------------------------|---|----------------|
| a | Start time selection field | d | Confirm button |
| b | Start time selection window | e | Rollers |
| c | Start time button | | |

Prerequisite Cooking program has ended
AutoChef automatic cooking menu open
 Advanced cooking function selected

1. Tap the *Start time selection* button.
 ↳ The *Start time selection* field displays the preset start time.
2. Using a swipe gesture, set the rollers to the desired temperature.
3. Tap the *Confirm* button.
 ↳ The start time selection is set to a new value.

5.6.4 Setting the core temperature

INFORMATION

You can find further information on working with the core temperature sensor under Using the core temperature sensor.

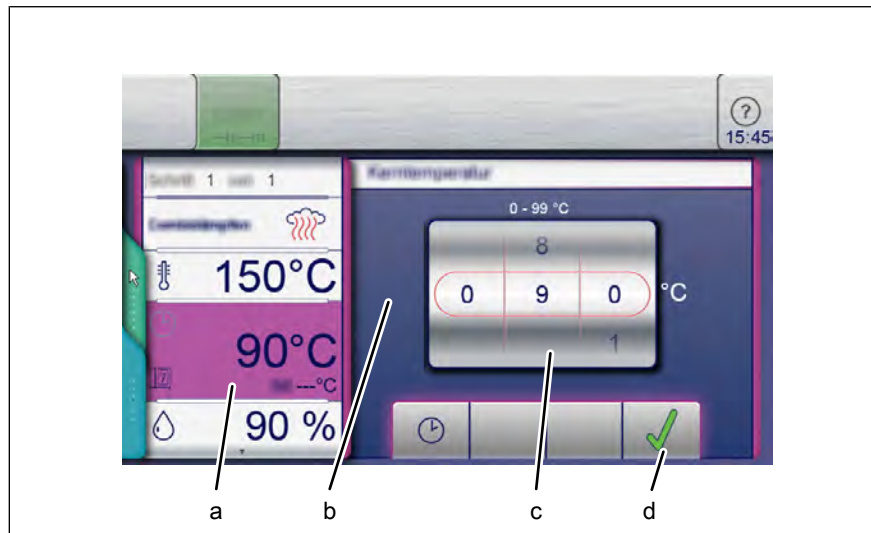

Image: Setting window for core temperature

- | | | | |
|---|------------------------|---|--------------------|
| a | Core temperature field | c | Temperature roller |
| b | Setting window | d | Confirm button |

Prerequisite Cooking program selected
Cooking time set

1. Tap the *Cooking time* field.
↳ The *Cooking time* setting window is displayed.
2. Tap the *Core temperature* field.
↳ The *Core temperature* setting window is displayed.
3. Using a swipe gesture, set the rollers to the desired temperature.
↳ Swipe up / down to increase / decrease the core temperature.
4. Tap the *Confirm* button.
↳ The *Setting* window closes.
↳ The *Cooking time* field changes to the *Core temperature* field.

5.6.5 Setting the fan speed and direction of rotation

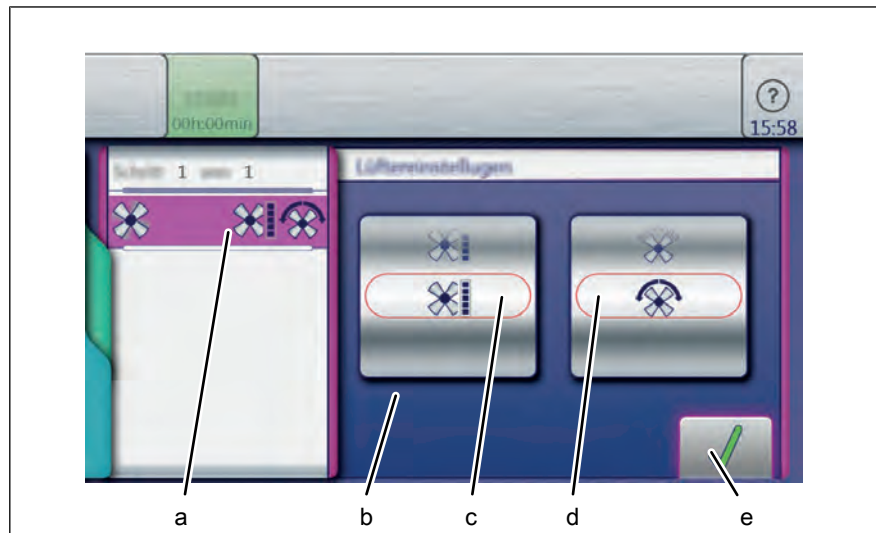

Image: Setting the fan speed and direction of rotation

- | | | | |
|---|-------------------|---|-------------------------------|
| a | Fan setting field | d | Fan rotation direction roller |
| b | Setting window | e | Confirm button |
| c | Fan speed roller | | |

Prerequisite Cooking program selected

1. Tap the *Fan setting* field.
↳ The Setting window opens.
2. Using a swipe gesture, set the *Fan speed* roller to the desired value.
3. Using a swipe gesture, set the *Fan rotation direction* roller to the desired value.
4. Tap the *Confirm* button.
↳ The fan speed and fan rotation direction are set.

5.6.6 Using Perfection (regeneration)

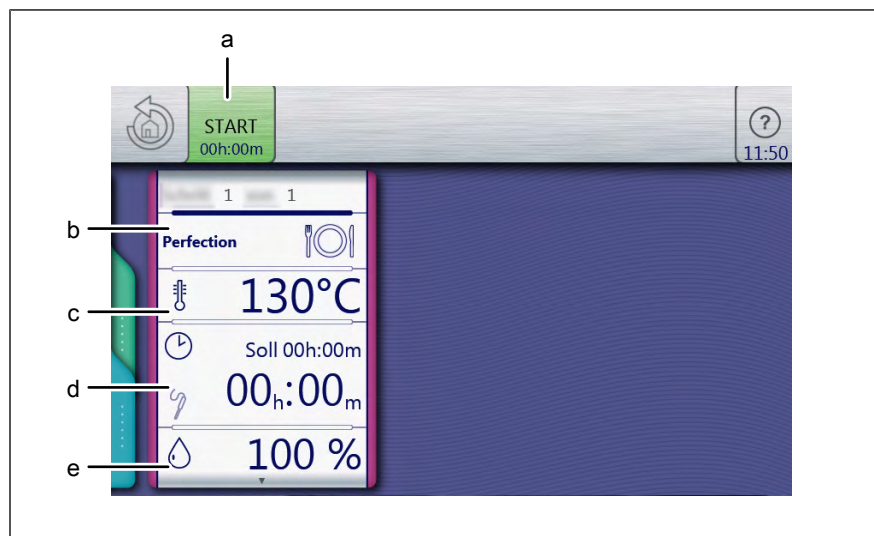

Image: Window for setting the Perfection cooking mode

- | | | | |
|---|--------------------|---|--------------------|
| a | "Start" button | d | Cooking time field |
| b | Cooking mode field | e | Moisture field |
| c | Temperature field | | |

Starting Perfection

- Prerequisite** Food to be cooked in the insert on the shelf
Door closed
Manual cooking menu displayed

1. Tap the *Perfection* mode field.
↳ The *Cooking mode* window is displayed.
 2. Configure the settings.
↳ The *Cooking mode* window shows the configured settings.
 3. Tap the "Start" button in the information strip.
↳ The unit heats up.
↳ The "Start" button is replaced with the "Stopp" button.
↳ The cooking time is updated in the *Cooking mode* window.
- ↳ Perfection is started.

Ending Perfection

- Prerequisite** Perfection started
Cooking time has not expired

1. Tap the "Stopp" button in the information strip.
- or

2. Wait until the cooking time ends.
 - ↳ Heating of the unit is ended.
 - ↳ The "Stop" button is replaced with the "Start" button.
 - ↳ The cooking time is reset.
- ↳ Perfection is ended.

5.6.7 Using PerfectHold

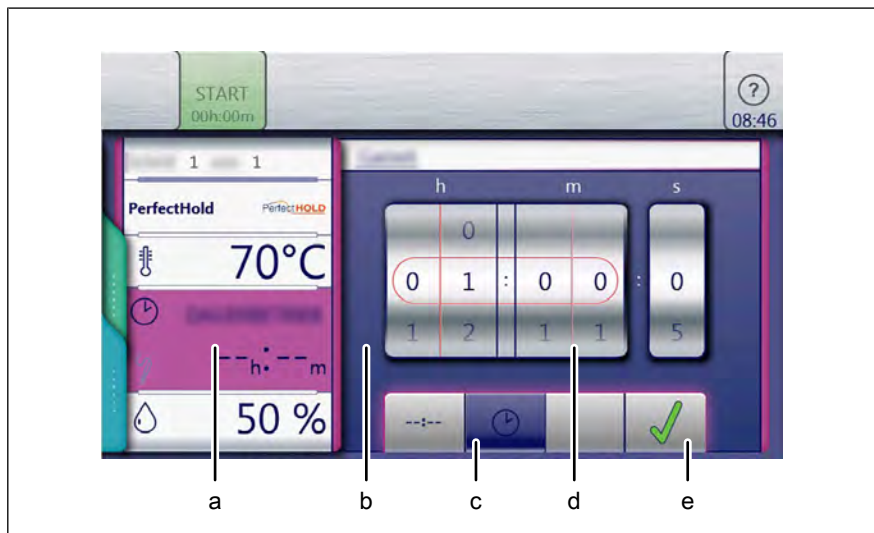

Image: Window for setting PerfectHOLD

- | | | | |
|---|---------------------|---|----------------|
| a | Cooking time field | d | Rollers |
| b | Setting window | e | Confirm button |
| c | Cooking time button | | |

Prerequisite Cooking program has ended
 Manual cooking menu open
 Advanced cooking function selected

1. Tap the *Temperature* field.
2. Using a swipe gesture, set the rollers to the desired temperature.
3. Tap the *Confirm* button.
 - ↳ The *Setting* window closes.
4. Tap the *Cooking time* field.
 - ↳ The *Setting* window is displayed.
5. Tap the *Cooking time* button.
6. Using a swipe gesture, set the rollers to the desired temperature.
 - ↳ Swipe up / down to increase / decrease the cooking time.
7. Tap the *Confirm* button.
 - ↳ The *Setting* window closes.
 - ↳ The *Cooking mode* window displays the set cooking time.
- ↳ PerfectHOLD is set for time control.

5.6.8 Ready2CookSetting

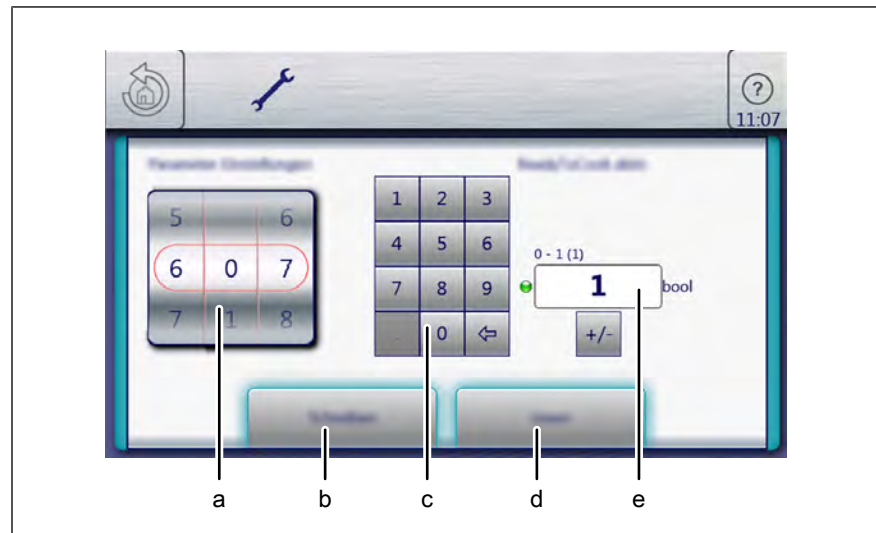

Image: Window for setting the "Ready2Cook" parameters

- a Rollers
- b Write button
- c Keyboard button
- d Read button
- e Display

Prerequisite Cooking function menu open

1. Tap the *Settings* field.
2. Enter and confirm PIN 111.
3. Tap the *Parameters settings* field.
 - ↳ The *Parameter settings* menu is displayed.
4. Using a swipe gesture, set the rollers to the desired temperature.
 - ↳ The designation of the selected parameter is displayed.
5. Tap the *Read* button.
 - ↳ The current value is displayed.
 - ↳ Switch the function on or off as necessary.
6. Delete the current value with the keyboard.
7. Enter the new value with the keyboard.
8. Tap the *Write* button.
 - ↳ The displayed value is applied.
 - ↳ The *Ready2Cook* function is set.

5.6.9 Steam Exhaust SystemUsing the (SES)

INFORMATION

The *Steam Exhaust System (SES)* automatically extracts the steam out of the cooking chamber.

It is on by default and can be switched off for individual programs.

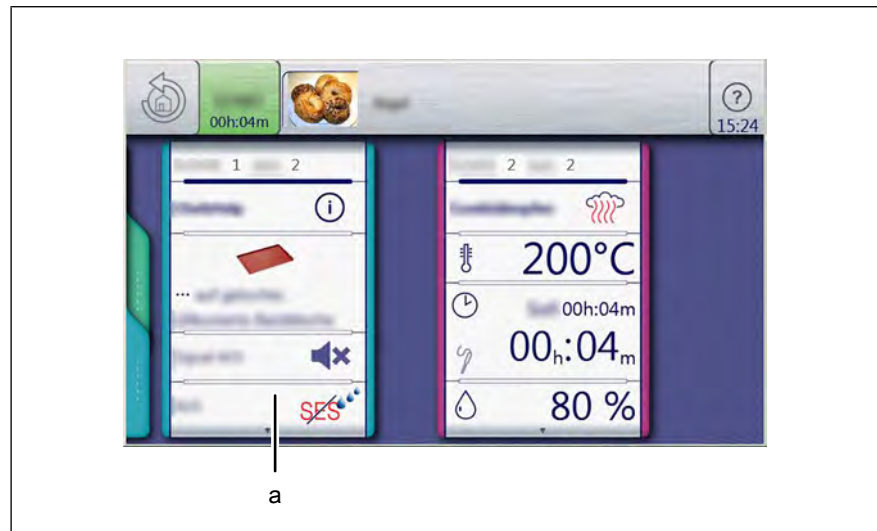

Image: Window for selecting the Steam Exhaust System (SES)

a *Steam Exhaust System* field

Prerequisite *Manual cooking* menu open

Desired cooking mode selected

The first step of the cooking program is created

1. Tap the field for the desired cooking mode.
2. Swipe upwards to open the next page.
 - ↳ The next page is opened.
 - ↳ The page with the *SES* field is displayed.
3. Switch the function on or off as necessary.
4. Tap the *SES* field.
 - ↳ The "ON" display switches automatically to "OFF" and vice versa.
 - ↳ The *SES* function is set.

5.6.10 RackControlUsing 2

INFORMATION

Set parameters such as the cooking time or core temperature can be changed for selected shelves during the cooking process. The cooking process is not interrupted.

Parameters such as the cooking chamber humidity, cooking chamber temperature and fan speed can be accessed and set.

These changes apply only to the currently running cooking program and are not retained as presets.

RackControlSetting and starting 2

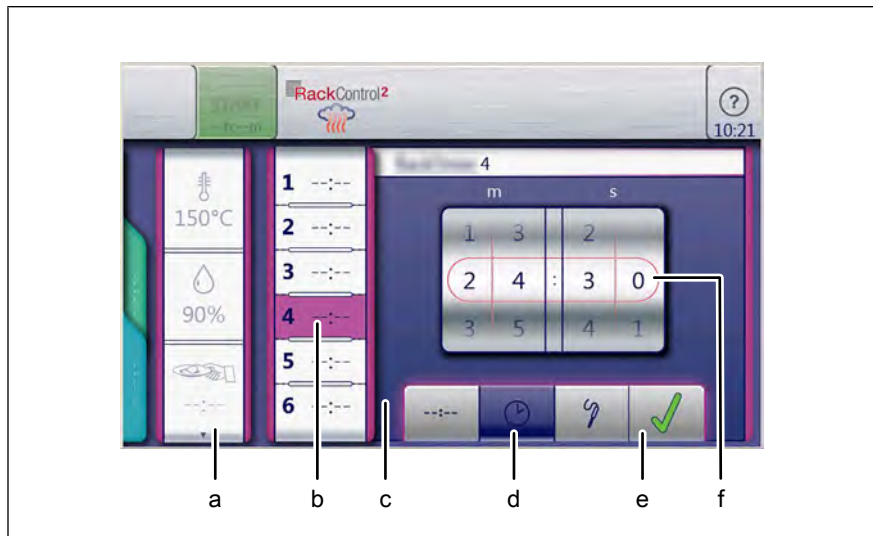

Image: Window for setting the RackControl2 cooking time

- a Settings field
- b Shelf field
- c Start time window
- d Start time button
- e Confirm button
- f Rollers

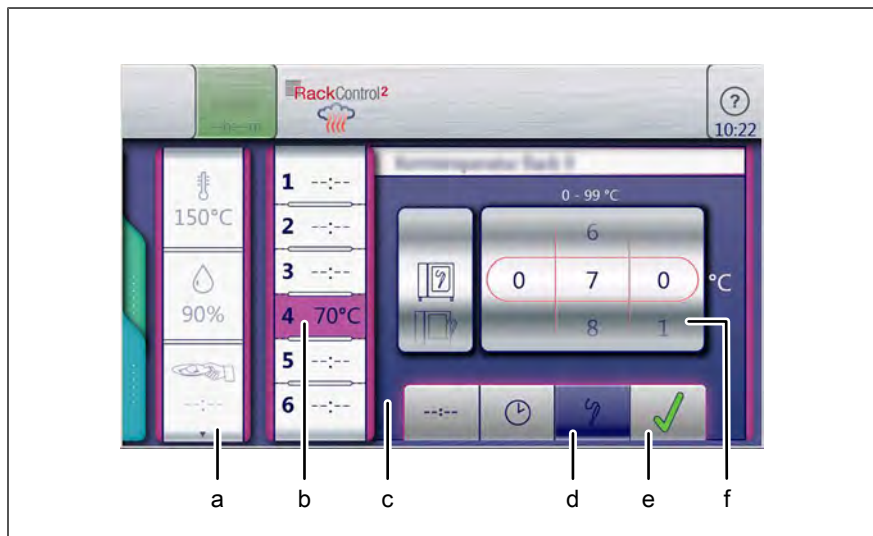

Image: Window for setting the RackControl2 core temperature

- a Settings field
- b Core temperature field
- c Core temperature window
- d Core temperature button
- e Confirm button
- f Rollers

Prerequisite Manual cooking field is selected

1. Tap the *RackControl2* field.
2. Tap the *Cooking mode* field.
3. Tap the *Settings* field.
4. Swipe upwards to open the next page.
↳ The next page with the *Fan setting* field is displayed.
5. Configure the fan settings as necessary.

6. Select the desired shelf.
7. Configure and confirm the desired settings (See "Setting the cooking time" and "Setting the core temperature").
 - ↳ RackControl2 is set for the selected shelf.
8. Configure settings for additional shelves as necessary.
9. Tap the "Start" button in the information strip.
 - ↳ The display changes to the "Actual value" display.
 - ↳ The unit heats up.
 - ↳ The "Start" button is replaced with the "Stopp" button.
- ↳ RackControl2 is started.

RackControlEnding 2

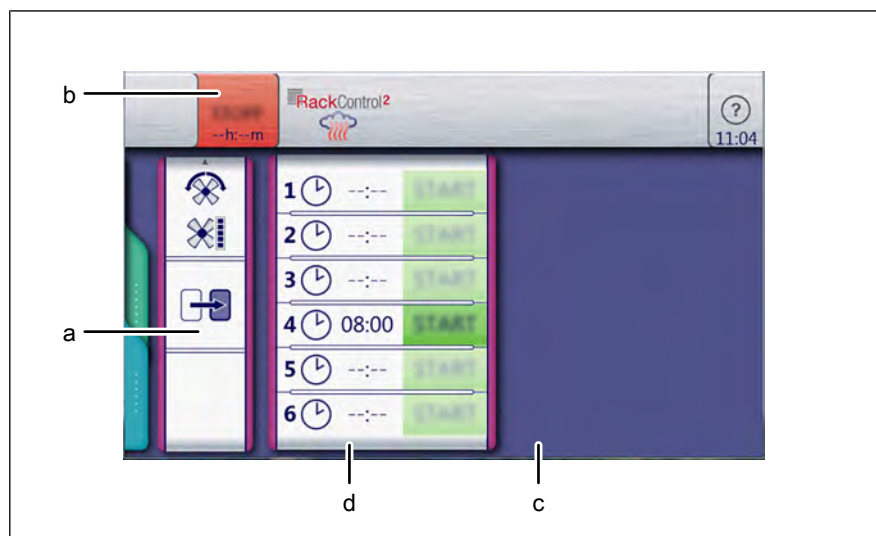

Image: Window for ending RackControl2 earlier

- | | | | |
|---|----------------|---|----------------|
| a | Continue field | c | Setting window |
| b | Stopp button | d | Shelf field |

Prerequisite RackControl2 is started

Preheat temperature not reached

1. Tap the *RackControl2* window.
 - ↳ The last *Setting* window is displayed.
2. Swipe upwards to open the next page.
3. Tap the *Continue* field.
 - ↳ Heating is interrupted.
- ↳ RackControl2 starts at the current temperature.

5.6.11 Time2ServeSetting

INFORMATION

The cooking time can be set for up to 23 hours and 59 minutes in 1-minute increments.

Continuous operation is stopped automatically after 23 hours and 59 minutes.

The hours and minutes appear in the display.

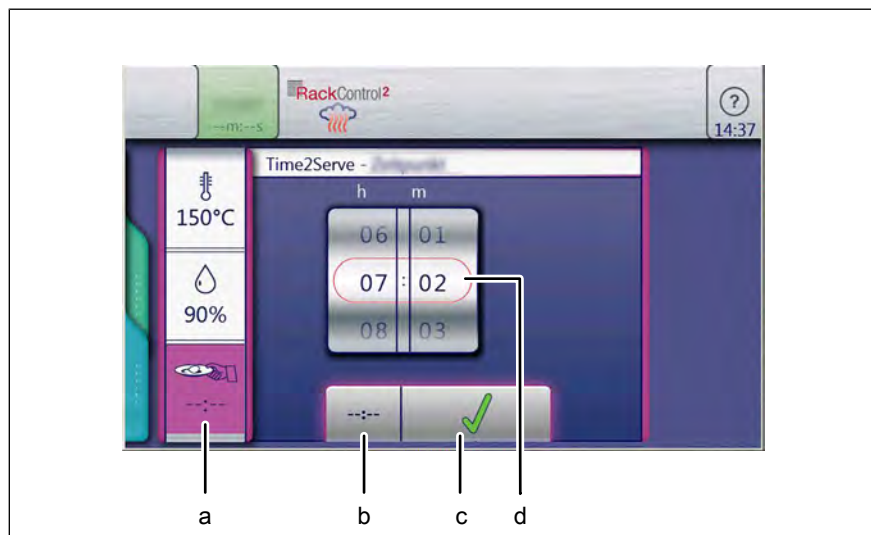

Image: Settings window for cooking timeTime2Serve

- | | | | |
|---|-----------------------------|---|----------------|
| a | Time2Serve field | c | Confirm button |
| b | Continuous operation button | d | Rollers |

Requirements *Manual cooking field selected*

1. Tap *RackControl2* field.
2. Tap *Cooking mode* field.
3. Tap *Time2Serve* field.
4. Using a wiping gesture, set the desired time.
 - ↳ Time2Serve is set.
5. Configure and confirm the settings for RackTimer (see "Using RackControl2").
 - ↳ RackControl2 is set for the selected shelf.
6. Configure settings for additional shelves as necessary.
7. Tap the "Start" button in the information strip.
 - ↳ The display changes to the "Actual value" display.
 - ↳ The unit heats up.
 - ↳ The "Start" button is replaced with the "Stopp" button.
- ↳ Time2Serve is started.
- ↳ RackControl2 is started.

5.6.12 FamilyMixUsing

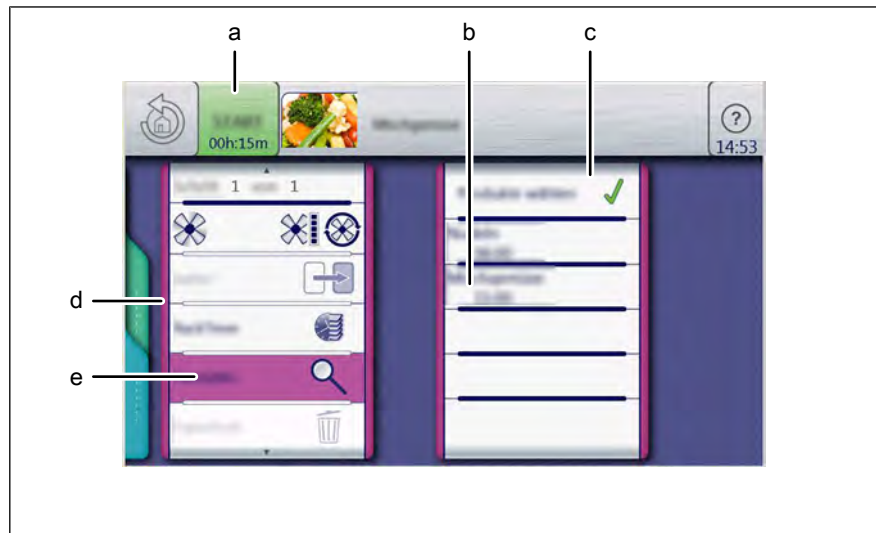

Image: Window for selecting FamilyMix

- a Start button
- b Product overview field
- c Product field
- d Settings field
- e FamilyMix field

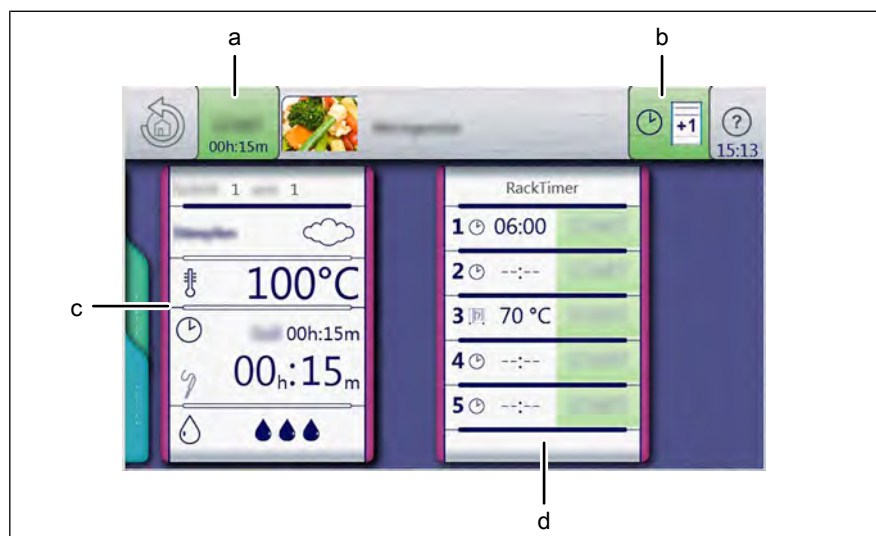

Image: Window for setting FamilyMix

- a Start button
- b Cooking time extension button
- c Setting field
- d fieldRackTimer

Prerequisite Manual cooking field is selected
Cooking program loaded

1. Tap the *Settings* field.
2. Tap the *FamilyMix* field.
3. Tap the *Product overview* field and select product.
 - ↳ Tap the *Product* field: The product is selected.
 - ↳ Tap the *Product* field again: Product selection is canceled.

4. Tap the "Start" button.
 - ↳ The display changes to "Ready2Cook".
 - ↳ The unit heats up.
 - ↳ The "Start" button is replaced with the "Stopp" button.
5. Wait until the cooking time ends.
 - ↳ Heating of the unit is ended.
 - ↳ The "Stopp" button is replaced with the "Start" button.
 - ↳ The cooking time is reset.
 - ↳ The *FamilyMix* function is set.

5.6.13 Using continue cooking

INFORMATION

When selecting products with different preset cooking times, the cooking time for selected products can be extended on an individual basis.

INFORMATION

Continue cooking can be set for up to 5 minutes in 1-minute increments.

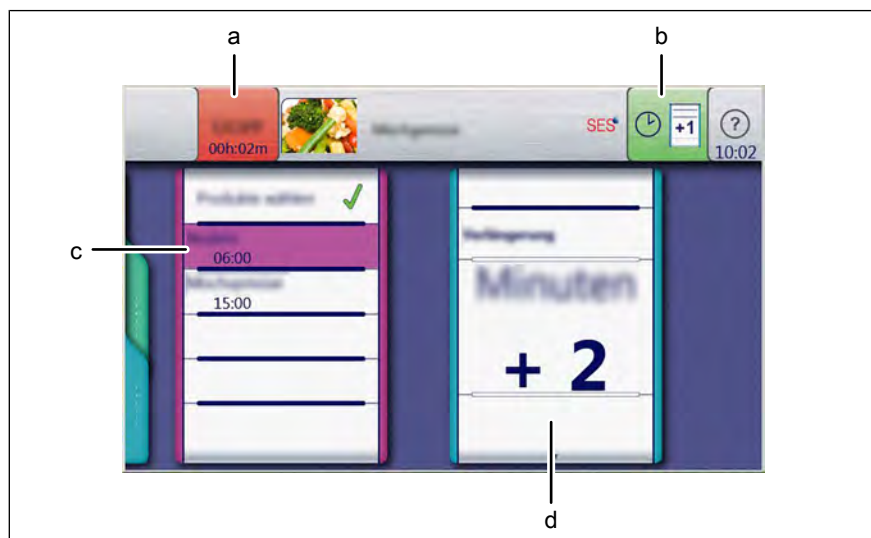

Image: Window for selecting cooking time extension

- | | | | |
|---|-------------------------|---|------------------------|
| a | Stopp button | c | Product field |
| b | Continue cooking button | d | Continue cooking field |

Prerequisite Cooking program selected
The *RackTimer* function is set

1. Tap the "Start" button.
 - ↳ The unit heats up.
 - ↳ The cooking program starts.
 - ↳ The "Start" button is replaced with the "Stopp" button.

2. Press the "Stop" button.
 - ↳ The cooking program is interrupted.
 - ↳ The "Continue cooking" button appears in the information strip.
 3. Tap the "Continue cooking" button.
 4. Since the desired time for continued cooking.
 - ↳ The cooking time is increased in 1-minute increments.
 - ↳ The modified cooking time applies only to the current cooking program.
 - ↳ It does not change the saved cooking program.
 - ↳ The *Continue cooking* function is set.
 5. Tap the "Start" button.
 - ↳ The cooking program starts.
 - ↳ The cooking time is extended by the desired time.
- ↳ The *Continue cooking* function is running.

5.6.14 Setting manual steaming

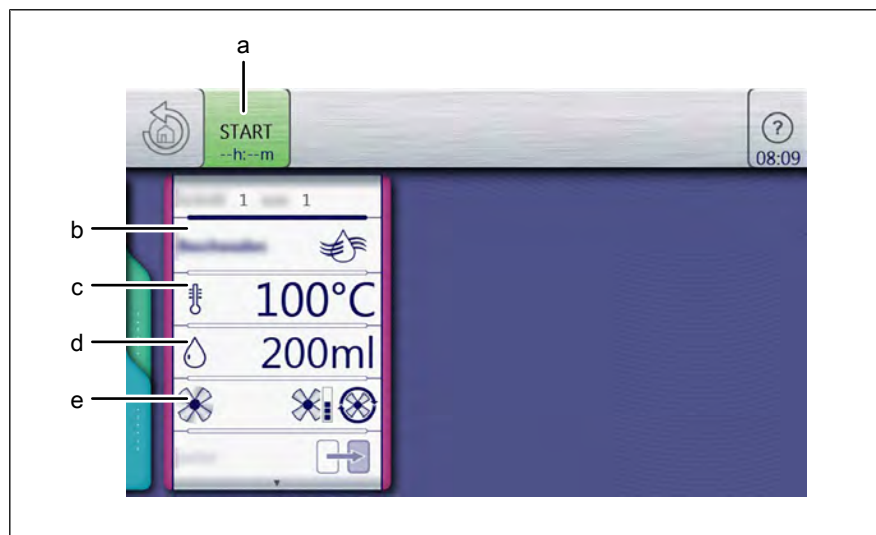

Image: Window for setting manual steaming

- | | |
|--------------------------------|--------------------------------|
| a "Start" button | d <i>Moisture amount</i> field |
| b <i>Manual steaming</i> field | e <i>Fan setting</i> field |
| c <i>Temperature</i> field | |

Prerequisite Manual cooking menu open
Advanced cooking function selected

1. Tap the *Temperature* field.
2. Using a swipe gesture, set the rollers to the desired temperature.
 - ↳ Swipe up / down to increase / decrease the cooking temperature.
3. Tap the *Confirm* button.
 - ↳ The *Setting* window closes.

4. Tap the *Desired injection amount* field.
 - ↳ The *Setting* window is displayed.
 5. Using a swipe gesture, set the rollers to the desired temperature.
 - ↳ Swipe up / down to increase / decrease the desired injection amount.
 6. Tap the *Confirm* button.
 - ↳ The *Setting* window closes.
- ↳ Manual steaming is set.

5.6.15 Setting a resting step

INFORMATION

The *Add resting step* function is available at any time.

Unless saved, the step applies only to the current cooking program.



Image: Window for adding a resting step

a Start button

b Resting step field

Prerequisite *Automatic cooking* menu open
Cooking program selected

1. Select the *New step* function.
2. Tap the *Resting step* field.
 - ↳ The *Manual cooking* menu appears.
3. Configure the settings.
 - ↳ Set the cooking mode.
 - ↳ Set the temperature.
 - ↳ Set the time.
 - ↳ Set the moisture.
4. Tap the "Start" button.
 - ↳ The *Resting step* is added to the current program.
 - ↳ The *Resting step* is not saved in the cooking program.

5. Save the cooking program.
↳ The *Resting step* is saved in the cooking program.

5.6.16 QualityControlUsing

INFORMATION

QualityControl is an automatic cooking time optimization function based on automatic temperature adjustment. It optimizes the preheating process.

It is on by default and can be switched off for individual programs.

INFORMATION

The current setting applies to all cooking programs until changed.

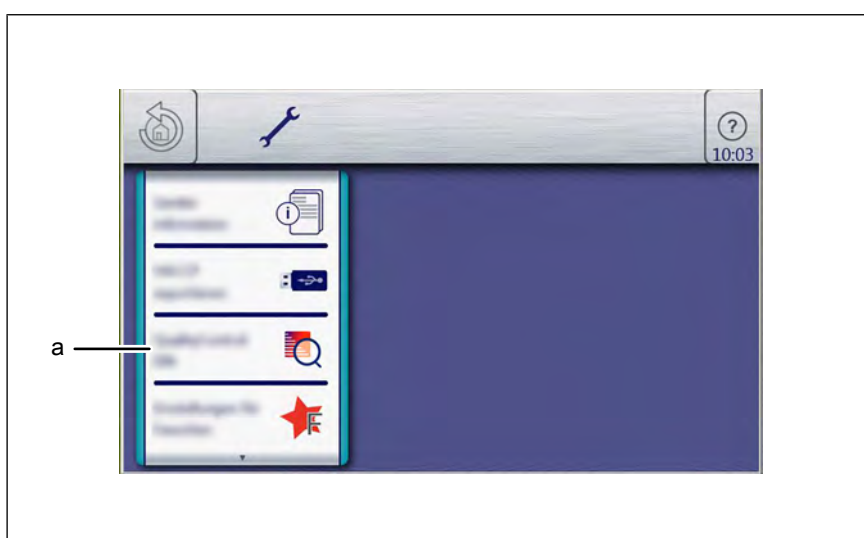

Image: Window for selecting QualityControl

a field *QualityControl*

Prerequisite *Cooking function* menu open

1. Tap the *Settings* field.
 2. Enter and confirm PIN *111*.
↳ The *QualityControl* field is displayed.
 3. Switch the function on or off as necessary.
 4. Tap the *QualityControl* field.
↳ The "ON" display switches automatically to "OFF" and vice versa.
- ↳ The *QualityControl* function is set.

5.6.17 Using LT cooking

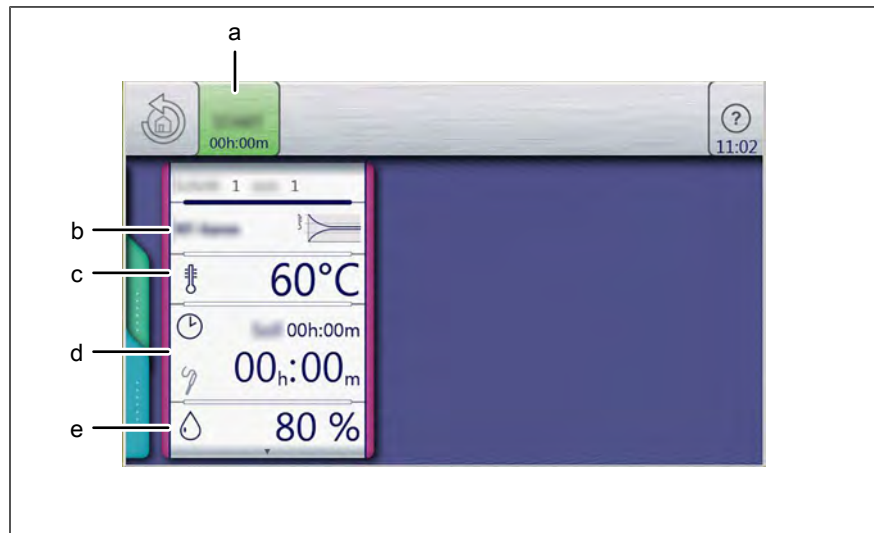

Image: Window for setting the Delta-T cooking mode

- | | | | |
|---|--------------------------------------|---|--------------------|
| a | "Start" button | d | Cooking time field |
| b | Cooking mode field | e | Moisture field |
| c | Cooking temperature difference field | | |

Starting LT cooking

Prerequisite Food to be cooked in the insert on the shelf

Core temperature sensor set

Door closed

Manual cooking menu displayed

1. Tap the *LT cooking* mode field.
↳ The *Cooking mode* window is displayed.
2. Configure the settings.
↳ The *Cooking mode* window shows the configured settings.
3. Tap the "Start" button in the information strip.
↳ The unit heats up.
↳ The "Start" button is replaced with the "Stopp" button.
↳ The cooking time is updated in the *Cooking mode* window.
↳ LT cooking is started.

Ending LT cooking

Prerequisite LT cooking started

Cooking time has not expired

1. Tap the "Stopp" button in the information strip.
- or

2. Wait until the cooking time ends.
 - ↳ Heating of the unit is ended.
 - ↳ The "Stop" button is replaced with the "Start" button.
 - ↳ The cooking time is reset.
- ↳ LT cooking is ended.

5.6.18 Using the barcode scanner

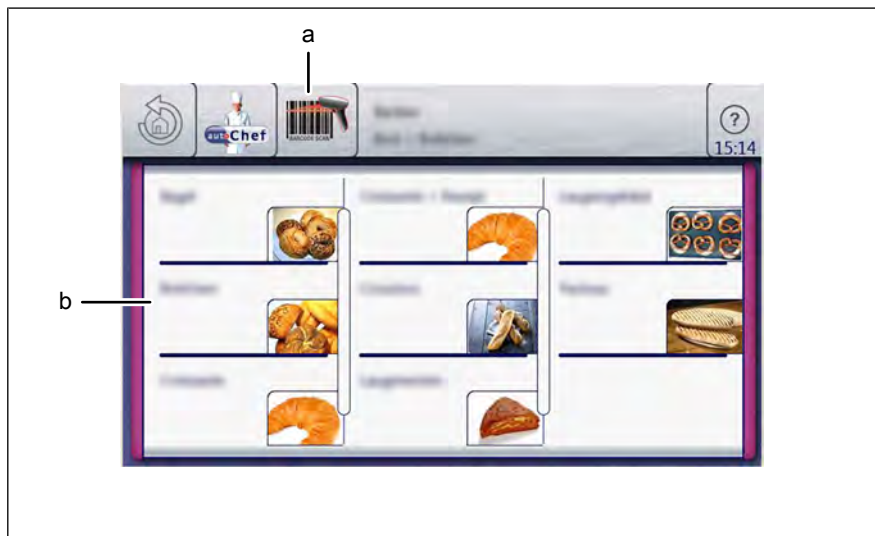

Image: Window for selecting the barcode scanner

a Barcode scanner button

b Product field

Requirements Barcode scanner connected
 Manual cooking field selected

1. Tap the "Barcode scanner" button.
2. Read the barcode.
 - ↳ A search for the product commences.
 - ↳ The cooking program is loaded.
- ↳ The *Barcode Scanner* function is utilized.

5.6.19 Inserting and removing the USB stick

Inserting the USB stick

Prerequisite USB stick with a minimum of 2 GB and maximum of 32 GB available storage capacity (not included with delivery)
 USB stick not write-protected

- Insert the USB flash drive.
 - ↳ The USB stick is ready after at most 20 seconds.

Removing the USB stick

Prerequisite Exporting or importing of data completed

- Remove the USB stick.

5.6.20 Preparing a USB stick for importing and exporting

Prerequisite USB stick is formatted
USB stick not write-protected

1. Create a folder structure for importing and exporting.
 2. Create a folder named "autoChefImages".
↳ Data exchange of photos in PNG format, resolution of 95x69 pixels, maximum resolution 150 KB.
 3. Create a folder named "FCBrowserFiles".
↳ Data exchange of text in HTML format.
 4. Create a folder named "FCImport".
↳ Data exchange from cookbooks.
 5. Create a folder named "MMIContent".
↳ Data exchange of additional imported content.
 6. Create a folder named "MMiUpdate".
↳ Data exchange of update files.
- ↳ Once the folder structure has been completed, the USB flash drive is ready for use.

5.6.21 Exporting the HACCP log

Prerequisite USB stick inserted
User logged in with password under unit settings

1. Tap the "Export HACCP" field.



2. Select the time period of the logs.
3. Tap the *Confirm* button.
↳ The *Operating instructions* window opens.
4. Tap the *Confirm* button.
↳ The HACCP log is exported to the USB stick.
↳ The *Confirm* window opens.
5. Tap the *Confirm* button.
↳ the *Confirm* window closes.

INFORMATION

The HACCP log can also be transferred via a kitchen guiding system.

5.7 Using the core temperature sensor**⚠ WARNING****Risk of injury from a bursting core temperature sensor**

- The core temperature sensor can burst as the result of overheating of the measuring tip.
- Never heat a core temperature sensor with a cigarette lighter or other heat source.

⚠ CAUTION**Risk of burns from hot surfaces**

- Grasp the core temperature sensor by the handle, remove it from the cooked food and carefully place it into the holder.
- Protect arms and hands by wearing suitable protective gloves.

INFORMATION

A core temperature measurement is always possible, if the core temperature sensor is inserted in the food being cooked. Also before or after a cooking process or during a time-controlled cooking step.

INFORMATION

Measuring the core temperature is recommended for all types of cooking to achieve an optimal result.

5.7.1 Measuring with a 4-point core temperature sensor

Image: Core temperature sensor with four measuring points

- Insert the core temperature sensor fully into the food to be cooked.
- Insert the core temperature sensor into the thickest section of the food to be cooked.
- When cooking food with a bone, insert the core temperature sensor close to the bone.
- When cooking longer pieces of food, insert the core temperature sensor across the food to avoid a hole in the center of the slice.

→ When cooking fowl, insert the core temperature sensor into the inside of the leg.

5.7.2 Measuring the core temperature when cooking frozen food

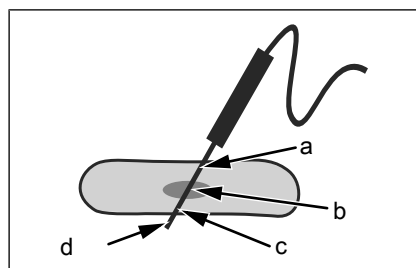
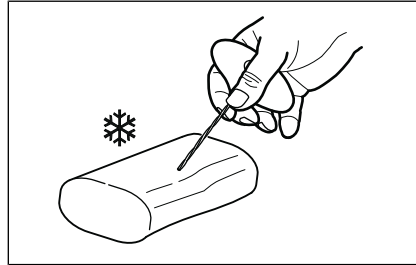
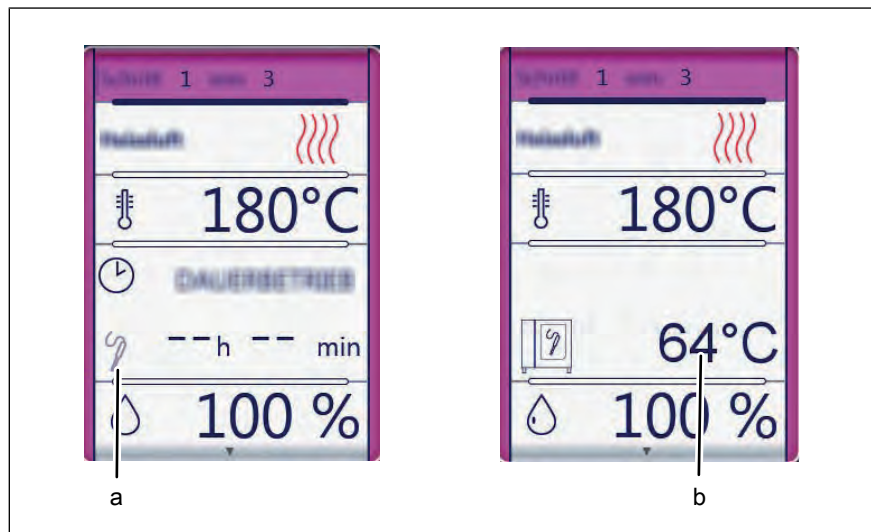

Image: Drilling an insertion duct with a hand drill

1. Use a hand drill to make an insertion duct for inserting the sensor.
2. Place the food to be cooked on the baking sheet or into the cooking pan.
3. Place the cooking sheet or cooking pan into the unit.
4. Insert the core temperature sensor into the food to be cooked.

5.7.3 Core temperature display with time-controlled cooking process



a Core temperature button

b Core temperature display

Prerequisite Core temperature sensor in the food being cooked
Time-controlled cooking process is running

1. Tap the *Core temperature* button in the cooking step display.
↳ The current core temperature is displayed for 5 seconds.

5.7.4 Core temperature display outside the cooking process

Requirements Core temperature sensor in the food being cooked

1. Open the *Unit function* menu.

2. Tap the "Measure core temperature" button on the second page.

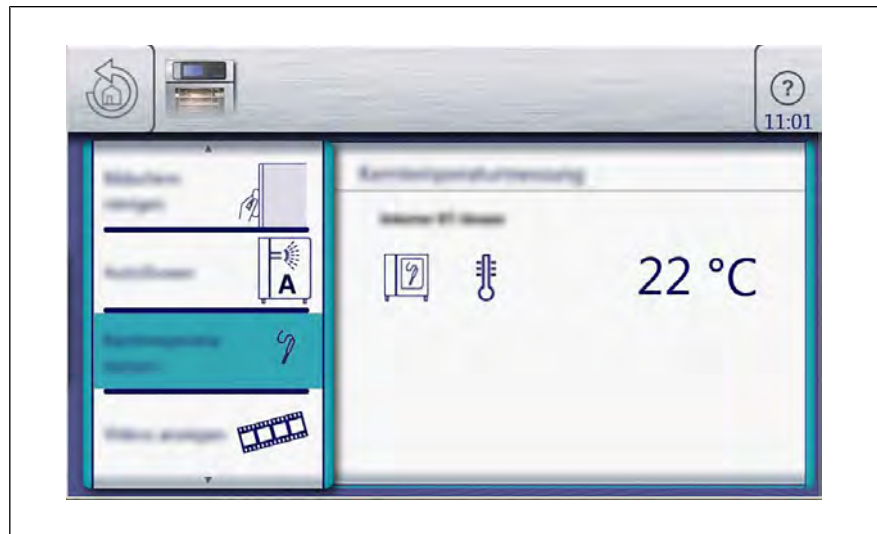

↳ The core temperature is displayed.

5.8 Manual cooking

Cooking modes and other functions are available in the Manual cooking mode. Selecting one of the components automatically creates a single-step cooking program.

Settings such as cooking mode, cooking temperature and cooking time are specified, and the cooking step is either started or saved.

5.8.1 Opening the Manual cooking menu

Prerequisite Unit is on
The Main menu is displayed

→ Tap the "Manual cooking" button.

↳ The *Manual cooking* menu is displayed.

5.8.2 Creating a cooking program step

Prerequisite Unit is on
The *Manual cooking* menu is displayed
Cooking mode selected

1. Tap the *Cooking temperature* field.

↳ The *Setting* window is displayed.

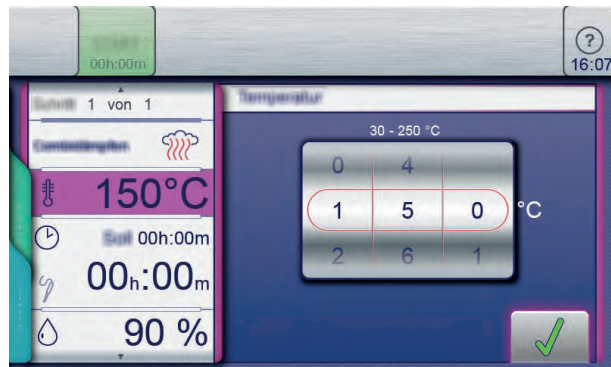

2. Using a swipe gesture, set the rollers to the desired value.
3. Tap the *Confirm* button.
↳ The *Setting* window closes.
4. Tap the *Cooking time* field.
↳ The *Setting* window is displayed.

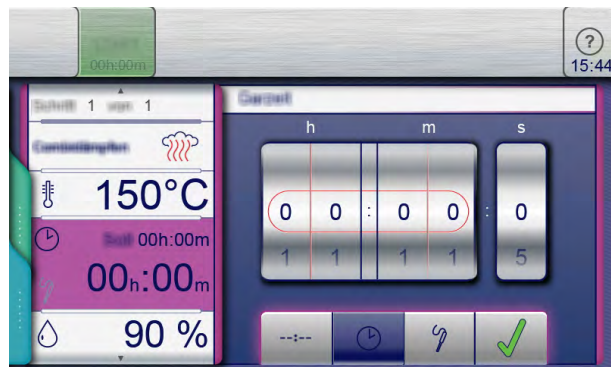

5. Tap the *Continuous operation* button or the *Cooking time* button or the *Core temperature* button.
6. Using a swipe gesture, set the rollers to the desired value.
7. Tap the *Confirm* button.
↳ The *Setting* window closes.
8. Tap cooking chamber humidity.
↳ The *Setting* window is displayed.

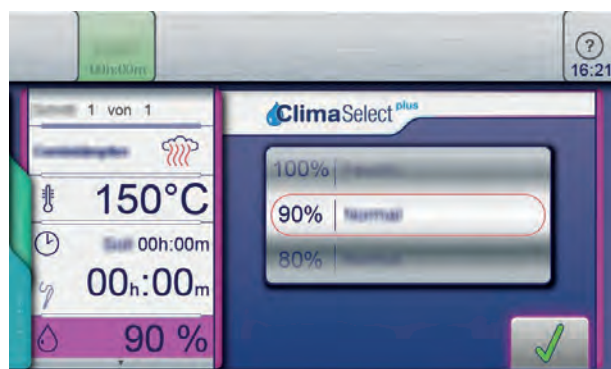

9. Using a swipe gesture, set the roller to the desired value.
10. Tap the *Confirm* button.
 - ↳ The *Setting* window closes.
11. Use a swipe gesture to change to the next page and make further settings.
12. Tap the *Fan* field.
 - ↳ The *Setting* window is displayed.



13. Set the fan speed and direction of rotation.
14. Using a swipe gesture, set the rollers to the desired value.
15. Tap the *Confirm* button.
 - ↳ The *Setting* window closes.
 - ↳ The cooking program can be started.

Tip

The cooking mode can also be changed while entering the cooking step.

- Tap the *Cooking mode* field.
 - ⇒ Possible selections appear.
- Tap the new cooking mode.
 - ⇒ The standard values of the selected cooking mode are displayed.
- Modify the values.
 - ⇒ Cooking mode for this cooking step is changed.

5.9 Creating and managing your own cooking programs

Cooking modes and other functions are available in the *Manual cooking* menu. Using these components, users can create their own programs.

NOTICE

Risk of property damage from data loss

Save your own cooking programs to an external storage device, e.g. a USB stick, regularly.

5.9.1 Creating a cooking program

Creating a cooking program step

Prerequisite *Manual cooking* menu open

1. Tap the field for the desired cooking mode.
 - ↳ The first step of the cooking program is created.
 - ↳ The cooking program step display reads "Step 1 of 1".
2. Modify the desired settings for the first step.
 - ↳ The first step of the cooking program has been created.

Adding cooking program steps

3. A swipe gesture upward opens the next page.
 - ↳ The next page is displayed.

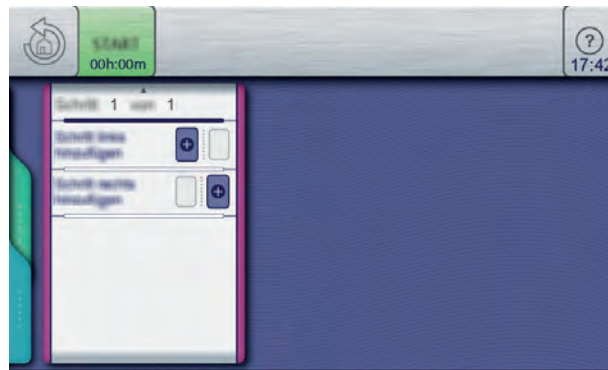

4. Tap the field "Add step at the left".
- or
5. the field "Add step at the right".
 - ↳ The "New step" window opens.
6. Select the cooking mode or function in the window by tapping it.
 - ↳ The cooking program step display in the window shows the current position of the new step in the cooking program.
7. Modify the settings for the step.
 - ↳ The new step is added.

Deleting a cooking program step

INFORMATION

If a cooking program has only one step, it cannot be deleted. The function is not active.

8. Select the step.
9. A swipe gesture upward opens the next page.
 - ↳ The next page for the step is displayed.
10. Tap the "Delete step" field.
 - ↳ The *Delete* window is displayed.



11. Tap the "Yes" button.

↳ This deletes the step.

↳ The positions of the remaining steps in the cooking program are updated.

↳ The step is deleted.

5.9.2 Saving the cooking program

NOTICE

Risk of property damage from data loss

Save your own cooking programs to an external storage device, e.g. a USB stick, regularly.

INFORMATION

Cooking programs that have been created can be saved prior to starting or after completion of the cooking program.

INFORMATION

To save a cooking program, at least one cooking program name and one category must be specified.

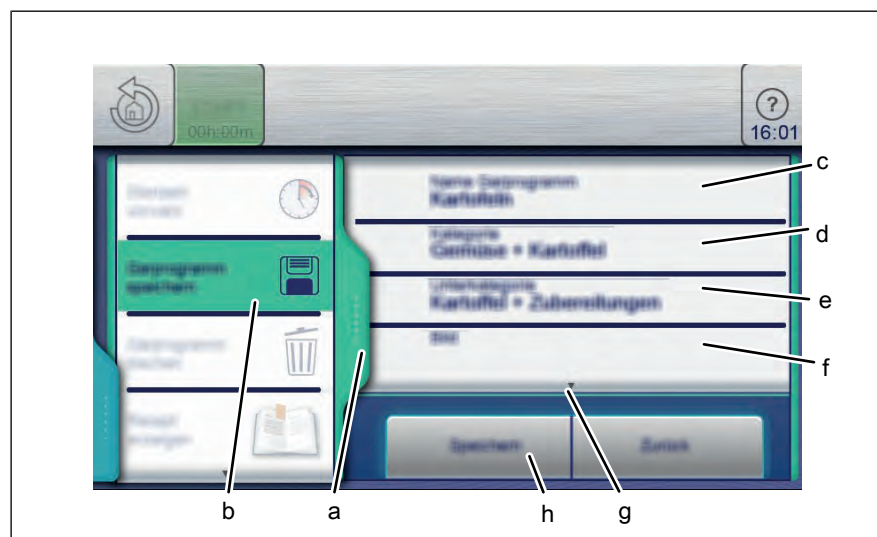

Image: Green tab and cooking program in the Save window

- | | |
|--------------------------------|--------------------------|
| a Green tab | e "Subcategory" field |
| b "Save cooking program" field | f "Image" field |
| c "Name cooking program" field | g Next page arrow symbol |
| d "Category" field | h "Save" button |

Prerequisite Cooking program is created and displayed

1. Tap the *green* tab.

↳ The *Tab* window is open.

2. Tap the "Save cooking program" field.
 - ↳ The *Save* window is open.
- ↳ Save after making the entries.

Saving the cooking program name

1. Tap the "Name cooking program" field.
 - ↳ The *Keyboard* menu is displayed.
2. Use the keys to enter the desired program name.
3. Tap the *Confirm* button.
 - ↳ The *Keyboard* menu closes.
 - ↳ The program name is displayed in the *Save* window.

Entering a category

1. Tap the "Category" field.
 - ↳ The *Automatic cooking (autoChef)* menu is displayed.
2. Tap the field with the desired *Category*.
 - ↳ The category is set.
 - ↳ The *Automatic cooking (autoChef)* menu closes.
 - ↳ The category is displayed in the *Save* window.

Entering a subcategory (optional)

1. Tap the "Subcategory" field.
 - ↳ The *Subcategory* menu is displayed.
2. Tap the field with the desired *Subcategory*.
 - ↳ The subcategory is set.
 - ↳ The *Subcategory* menu closes.
 - ↳ The subcategory is displayed in the *Save* window.

Assigning an image (optional)

1. Tap the "Image" field.
 - ↳ The *Image* menu is displayed.
2. Select a photo by tapping it.
3. Select the location to save the photo.
4. Tap the "Photos in unit" button or the "Photos on USB stick" button.
 - ↳ The photo is selected.
 - ↳ The *Image* menu closes.
 - ↳ The name of the photo is displayed in the *Save* window.

Assigning a video (optional)

1. Tap the "Video" field.
 - ↳ The *Video* menu is displayed.
2. Select the video by tapping it.

3. Select the location to save the photo.
4. Tap the button for "Videos in unit" or "Videos on USB stick".
 - ↳ Video is selected.
 - ↳ The *Video* menu is closed.
 - ↳ The name of the video is displayed in the Save window.

Assigning a recipe (optional)

1. Tap the "Recipe" field.
 - ↳ The *Recipe* menu is displayed.
2. Tap the "Empty recipe" field.
3. Select the save location.
4. Tap the "Recipes in unit" button or the "Recipes on USB stick" button.
 - ↳ The recipe is set.
 - ↳ The *Recipe* menu closes.
 - ↳ The name of the recipe is displayed in the *Save* window.

Selecting favorites (optional)

1. Tap the "Show favorites" field.
 - ↳ The *Show favorites* menu is displayed.
2. Tap the "Yes" button or the "No" button.
 - ↳ Tapping Yes displays the cooking program in the Favorites menu.

Selecting characteristics of the food to be cooked (optional)

1. Tap the "Frozen food" field.
 - ↳ The *Frozen food* menu is displayed.
2. Tap the "Yes" button or the "No" button.
 - ↳ Tapping Yes selects the food to be cooked as a frozen food.

Assigning an identification (optional)

1. Tap the "Identification" field.
 - ↳ The *Identification* menu is displayed.
 2. Use the keyboard to enter the barcode.
- or
3. Read the barcode with the barcode scanner.
 - ↳ Scan the barcode and assign to a cooking program or to food to be cooked.

Selecting QualityControl

1. Tap the "QualityControl" field.
 - ↳ The *QualityControl* menu is displayed.

2. Tap the "No" button.
 - ↳ QualityControl is deactivated for the cooking program.
3. Tap the "Yes" button.
 - ↳ Tapping Yes sets the cooking program for a minimal amount of food to be cooked.
 - ↳ QualityControl automatically adjusts the cooking time for a larger charge.

5.9.3 Exporting a cooking program

INFORMATION

Previously exported cooking programs on the USB stick will be overwritten.

Prerequisite Cooking program open
Cooking program saved
USB stick inserted

1. Tap the *green* tab.
 - ↳ The *Tab* window is open.
2. Tap the "Export cooking programs" field.
 - ↳ The *Operating instructions* window opens.



3. Read the displayed operating instructions.
4. Tap the *Confirm* button.
 - ↳ The cooking program is exported to the USB stick.
 - ↳ The *Confirm* window is displayed.
5. Tap the *Confirm* button.
 - ↳ The *green tab* window closes.
 - ↳ The cooking program is exported.

5.10 Automatic cooking (autoChef)

In the "Automatic cooking" mode, all cooking programs stored in the unit are available. The cooking program is selected in the *Automatic cooking* menu.

5.10.1 Opening the Automatic cooking menu

- Prerequisite** Unit is on
The Main menu is displayed
- Tap the "Automatic cooking" button.
↳ The *Automatic cooking (autoChef)* menu is displayed.

5.10.2 Finding and opening a cooking program

Finding and opening a cooking program by category

Cooking programs can be found in the *Automatic cooking* menu by category and subcategory.

INFORMATION

Arrow symbols in a window always display the next or previous page. A swipe gesture upward or downward opens the corresponding window.

- Prerequisite** Unit is on
Main menu is displayed
1. Tap the "Automatic cooking" button.
↳ The *Automatic cooking* menu is displayed.
 2. Tap the field with the desired Category.
↳ The Subcategory menu is displayed.
 3. Tap the field with the desired subcategory.
↳ The Recipe menu with all recipes in the subcategory is displayed.
 4. Tap the field with the desired recipe.
↳ The cooking program is selected and being loaded.
↳ The cooking program steps are displayed.
- ↳ The cooking program is open.

Finding and opening a cooking program in the cookbook

All cooking programs are saved in the cookbook in alphabetical order.

- Prerequisite** Unit is on
Main menu is displayed
1. Tap the "Automatic cooking" button.
↳ The Category menu is displayed.
 2. Tap the "autoChef" button in the information strip.
↳ The *autoChef* window is displayed.



3. Tap the *Find cooking program* field.
 - ↳ The *Search* window is displayed.
 4. Using the keyboard, enter the letters for the name to be found.
 - ↳ A filtered list is displayed in the *Result* window.
 5. Tap the field with the name found.
 - ↳ The cooking program is selected and being loaded.
 - ↳ The cooking program steps are displayed.
- ↳ The cooking program is open.

5.10.3 Starting the cooking program

INFORMATION

The current step in the cooking program is highlighted. Upon completion, the following step automatically appears in the display.

Prerequisite Cooking program open

1. Tap the "Start" button in the information strip.
 - ↳ The cooking program starts.
 - ↳ The "Start" button in the information strip changes to the "Stopp" button
 - ↳ The remaining cooking program time is displayed in the "Stopp" button.
- ↳ The cooking program is started.

5.10.4 Ending the cooking program

Prerequisite Cooking program started
Cooking program time has not elapsed

1. Tap the "Stopp" button in the information strip.
- or

2. Wait for the cooking time to end.
 - ↳ Cooking program has ended.
 - ↳ The "Stopp" button in the information strip changes to the "Start" button
 - ↳ The cooking program has ended.

INFORMATION

If the cooking chamber door is not opened, the fan continues to run at a low speed at intervals. This achieves even cooking.

INFORMATION

If the current cooking process is stopped manually, a window appears under certain circumstances with *Cooking program has been interrupted*.

You then have the opportunity to end or continue the cooking program.

5.10.5 Modifying the cooking program

INFORMATION

Tabs are available only within cooking programs or the cooking step display. Tapping the tabs provides faster access to their functions.

INFORMATION

The current step in the cooking program is highlighted and can be modified. All settings of a step can be modified.

INFORMATION

After the settings are made, the modified cooking program can be saved. The cooking program is overwritten if a new cooking program name is not specified.

Modifying a cooking program after the program has started

Prerequisite Cooking program started
 Cooking program has not elapsed

1. Modify the settings for the current step.
 - ↳ The modifications of the step become active immediately.
 - ↳ The modifications of the step are displayed.
2. Tap the "Continue" field.
 - ↳ The active step is being ended.
 - ↳ The next step is being started.
 - ↳ Steps advance in the *Settings* window.
 - ↳ The cooking program is modified.

Modifying a cooking program before the program has started

Prerequisite Cooking program open
Cooking program not started

1. Modify various steps.
2. Use a swipe gesture to reach the individual step to be modified.
3. Modify the settings for the step.
 - ↳ The modifications of the step are displayed.
 - ↳ The cooking program can be started without being saved.
 - ↳ If the modifications are to be saved, continue with the next step.
4. Tap the *green* tab.
 - ↳ The *Tab* window is open.
5. Save the cooking program.
 - ↳ All modifications to the cooking program are saved.
 - ↳ The saved cooking program is modified.

5.10.6 Deleting a cooking program

Prerequisite Cooking program open
Cooking program not started

1. Tap the *green* tab.
2. The *Tab* window is open.
3. Tap the "Delete cooking program" field.
 - ↳ The *Delete* window is displayed.

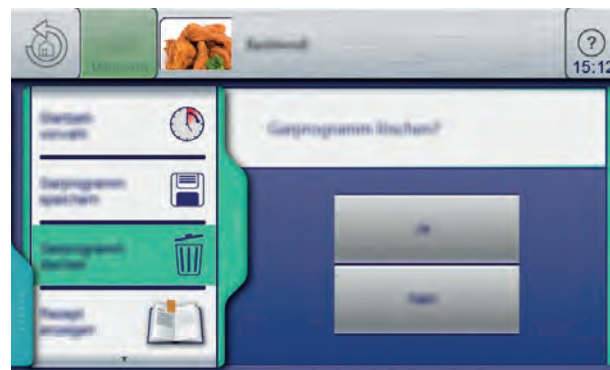

4. Tap the "Yes" button.
 - ↳ The cooking program is being deleted.
 - ↳ The *Confirm* window is displayed.
5. Tap the *Confirm* button.
 - ↳ The *green* tab closes.
 - ↳ The cooking program is deleted.

5.10.7 Exporting and importing a cooking program

Exporting cooking programs

When exporting, all of the user-created cooking programs in the cookbook are exported.

INFORMATION

Previously exported cooking programs on the USB stick will be overwritten.

Prerequisite USB stick inserted

Automatic cooking menu open

User-created cooking programs are saved in the cookbook

1. Tap the "autoChef" button in the information strip.
 - ↳ The *autoChef* window opens.
2. Tap the "Export cooking programs" field.
 - ↳ The *Operating instructions* window opens.
 - ↳ Read the displayed operating instructions.



3. Tap the *Confirm* button.
 - ↳ All user-created cooking programs are exported to the USB stick from the cookbook.
 - ↳ The *Confirm* window is displayed.
 4. Tap the *Confirm* button.
 - ↳ The *Confirm* window closes.
- ↳ The cooking programs are exported.

Import cooking programs

When importing, the new cooking programs are added to the cookbook.

INFORMATION

Existing cooking programs can be overwritten or the file names of the imported cooking programs can have a supplement added.

Prerequisite USB stick inserted
Automatic cooking menu open.

1. Tap the "autoChef" button in the information strip.
↳ The *autoChef* window opens.
2. Tap the "Import cooking programs" field.
↳ The *Operating instructions* window opens.
↳ Read the displayed operating instructions.



3. Tap the *Confirm* button.
↳ All cooking programs on the USB stick are imported to the cookbook.
↳ The *Operating instruction* window is displayed.
4. Tap the "OK" button.
↳ The cooking programs are imported.

5.11 VideoAssist

5.11.1 Watching a video

Prerequisite Videos saved on the unit.

1. Open the *Unit functions* menu.
2. Open the *Display videos* menu.

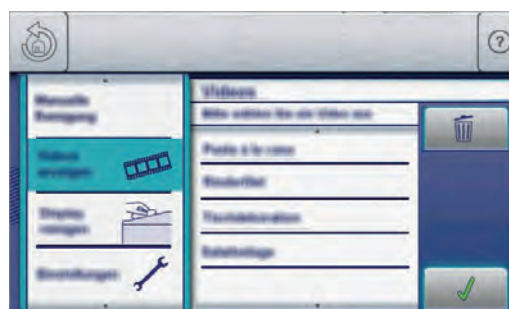

3. Select the video by tapping it.

4. Tap the *Confirm* button.

↳ The video is played.

5.11.2 Deleting a video

Prerequisite The *Display videos* menu is open.

1. Tap the field *Delete*.

↳ The *Delete* field becomes dark.

2. Tap the videos to be deleted.

↳ The *Delete* symbol appears behind the designation of the video.

↳ If you tap again on the video, the selection deletes this video.



3. Touch the *Confirmation* field.

↳ The marked videos are deleted.

5.12 Pausing and ending operation

Switch off the unit during pauses and at end of operation.

5.12.1 Performing a hygiene flush after an extended period of idleness

For reasons of hygiene, flush the water lines in the unit and on-site water lines before using the unit.

Period of idleness lasting more than 2 days

Requirements GN containers, baking sheets and grates removed from the cooking chamber

No food to be cooked in the cooking chamber

1. Rinse the cooking chamber thoroughly with clear water.
2. Run the unit in the Steaming mode for 7 minutes at 100 °C (212 °C).

Period of idleness lasting more than 7 days

Requirements GN containers, baking sheets and grates removed from the cooking chamber

No food to be cooked in the cooking chamber

1. Rinse the cooking chamber thoroughly with clear water.
2. Run the unit in the Steaming mode for 1 hour at 100 °C (212 °C).

6 Cleaning and caring for the unit

CAUTION

Risk of burns from hot surfaces

- Allow surfaces to cool prior to cleaning.

NOTICE

Risk of property damage from extremely abrupt cooling

- Do not shock the unit by cooling it abruptly.

NOTICE

Risk of property damage from improper cleaning

- Do not clean the unit with a high-pressure cleaner or water jet.

CAUTION

Risk of chemical burns from cleaning agent

- Follow the instructions of the cleaning agent manufacturer.
- Take appropriate protective measures when handling aggressive cleaning agents.

6.1 Preventing corrosion

- Keep the surfaces of the unit clean, with access to air.
- Remove lime, grease, starch and protein deposits from the unit's surfaces.
- Remove salt accumulations.
- Expose parts made from non-rusting steel only briefly to contact with highly acidic foods, spices, salts or the like.
- Avoid damaging the stainless steel surface with other metal items, for instance, steel spatulas or steel wire brushes.
- Prevent contact with iron and steel, for instance, steel wool and steel spatulas.
- Do not use bleaching or chlorine-containing cleaning agents.
- Clean contact surfaces with water.

6.2 Removing rust spots

- Remove fresh rust spots with a mild abrasive or fine sandpaper.
- Always remove rust spots completely.
- Expose treated areas to fresh air for at least 24 hours. During this time, do not allow any contact with greases, oils or foods so that a new protective layer can form.

6.3 Cleaning the housing

Prerequisite Unit switched off and cooled down

→ Clean the housing with warm water and a commercially available detergent.

6.4 Cleaning the door handle, operating elements and control panel

NOTICE

Risk of property damage from improper cleaning

- Do not clean the surface with highly abrasive or chemically aggressive cleaning agents.
- Do not clean the surface with highly abrasive sponges.

Prerequisite Unit dead

→ Clean the door handle, operating elements and control panel with a damp cloth and commercially available detergent.

6.5 Cleaning the touchscreen

NOTICE

Risk of property damage from improper cleaning

- Do not clean the touchscreen with highly abrasive or chemically aggressive cleaning agents.
- Do not clean the touchscreen with highly abrasive sponges.

INFORMATION

A cleaning time of 20 seconds is provided. During this time, the touchscreen cannot be operated.

Prerequisite *Unit function* menu displayed

1. Tap the "Clean touchscreen" field.
 - ↳ The touchscreen no longer reacts when touched.
 - ↳ The *Clean* window is displayed.
 - ↳ The cleaning time is updated.
 2. Clean the touchscreen within 20 seconds.
 - ↳ The *Clean* window closes.
 - ↳ The *Unit function* menu is displayed.
- ↳ The touchscreen is clean.

6.6 Cleaning the door seal

NOTICE

Risk of property damage from improper cleaning

Animal fats in combination with high temperatures can damage the door seal very quickly if it is not maintained properly.

- Clean the door seal regularly.
- Do not use aggressive cleaners.

INFORMATION

During automatic cleaning and semi-automatic cleaning, the outside surface of the door seal is not cleaned.

The door seal must be cleaned separately.

INFORMATION

If the unit is used primarily for roasting, also clean the door seal during pauses in use.

→ When finished using the unit, clean the door seal with warm water and a commercially available detergent.

6.7 Cleaning the cooking chamber door

⚠ CAUTION

Risk of burns from hot surfaces

- Allow surfaces to cool prior to cleaning.

NOTICE

Risk of property damage from improper cleaning of the surface

- Do not use abrasive cleaners or cloths.
- Do not use grill cleaners.

NOTICE

Risk of property damage from improper cleaning

- Do not clean the surface with highly abrasive or chemically aggressive cleaning agents.
- Do not clean the surface with highly abrasive sponges.

6.7.1 Cleaning the door with hygienic glazing

→ Remove residual calcium deposits from the glass window with vinegar or citric acid.

6.8 Cleaning recirculation hood

⚠ CAUTION

Risk of fire from dirt and grease accumulation

- Clean the hood after use.
- Follow the cleaning instructions.

⚠ CAUTION

Risk of burns from hot surfaces

- Allow surfaces to cool prior to cleaning.

⚠ CAUTION

Risk of injury from sharp edges

- Wear protective gloves.

⚠ CAUTION

Risk of falling from unstable climbing aids

- Use only approved ladders or step stools as climbing aids.

6.9 Cleaning the recirculation hood filter

INFORMATION

Use a stable, approved and tested step ladder for cleaning, inspecting and changing filters.

INFORMATION

Inspect the air filter regularly for contamination.
Change the air filter if required.

INFORMATION

Do not operate the unit without air filter.

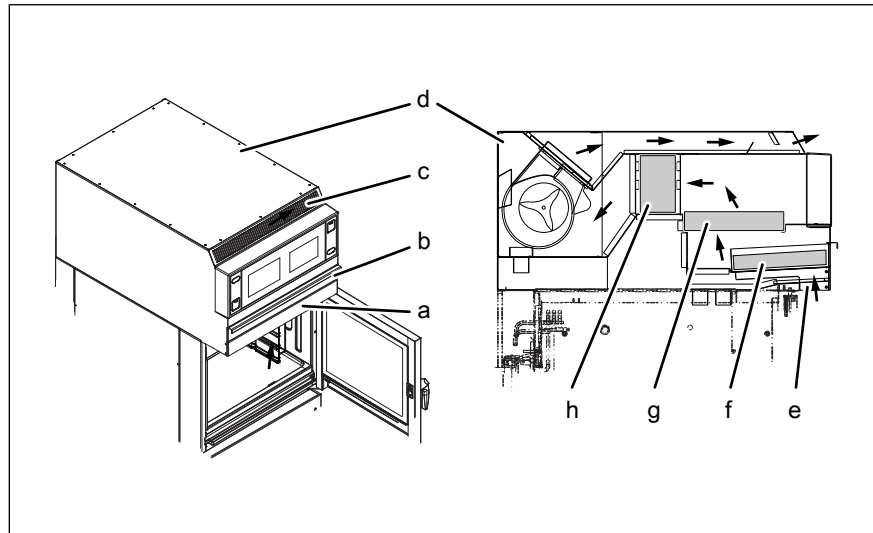

Image: Recirculation hood filter

- | | | | |
|---|---------------------|---|---------------------------|
| a | Condensation baffle | e | Vapor inlet |
| b | Filter drawer | f | Filter mat (yellow) |
| c | Air outlet | g | Air filter |
| d | Recirculation hood | h | Activated charcoal filter |

6.9.1 Cleaning the yellow filter mat

NOTICE

Risk of property damage from improper cleaning

Do not use a fabric softener when cleaning the yellow filter mat.

Always wash the yellow filter mate separately.

Reinstall only a fully dried filter mat.

Requirements

Disconnect the recirculation and associated unit from power

Unit has cooled down

Step ladder set up securely

1. Remove yellow filter mat, incl. holder.
2. Remove yellow filter mate from holder.

Manual washing

1. Allow the yellow filter pad to soak for 5 minutes in a basin of warm water and commercially available cleaning agent.
2. Knead it thoroughly several times, but do not wring it.
3. Wash it out under clear, warm water and press out the water.
4. Repeat both procedures, until the water does not show any more discolouration.
5. After washing the filter pad, dry it on a smooth, horizontal substrate at ground level.

Machine washing

1. Before washing the yellow filter mat, spray it thoroughly with a grease remover and allow it to act.

2. For normal soiling, wash at 30 °C (86°F).
 3. For sever soiling, wash at 60 °C (140°F).
 4. Spin at max. 800 rpm.
 5. After washing the filter pad, dry it on a smooth, horizontal substrate at ground level.
 6. Place dry yellow filter mat into holder and close holder.
 7. Place holder with filter mat into filter drawer.
- ↳ The yellow filter mat is cleaned.

6.9.2 Changing air filter in recirculation hood

Requirements Unit switched off
Unit has cooled down
Step ladder set up securely

1. Remove the filter drawer with the filter.
2. Unhook the condensation baffle.
3. Lift the air filter out of the holder at the rear.
↳ The air filter drops out of the front holder.
4. Remove the air filter from the front.
5. Insert a new air filter into the holders.
6. Make sure that the filter is in the correct position.
↳ The air filter lies in the holders.
7. Hook the condensation baffle back in.
8. Push the filter drawer in as far as the end stop.
↳ Air filter changed in the recirculation hood.

6.9.3 Cleaning the condensation area

Requirements Disconnect the recirculation and associated unit from power
Unit has cooled down
Step ladder set up securely

1. Remove the filter drawer with the filter.
2. Unhook the condensation baffle.
3. Clean the condensation area with the cleaning brush, warm water and commercially available cleaning agent.

6.9.4 Inspecting the active carbon filter

The manufacturer recommends professional cleaning of the unit by trained technical personnel in 12-month intervals. With a heavier use, a maintenance interval of 6 months is recommended.

6.10 Removing calcium deposits from the unit

INFORMATION

To remove calcium deposits manually, fill a manual spray gun with a special decalcifier.

Prerequisite Cooking chamber temperature less than 40 °C (104°F)
Cooking chamber cleaned

1. Dilute special decalcifier with water in a ratio of 1:2.
2. Spray the diluted special decalcifier into the cooking chamber.
3. Allow to act for 30 minutes.
4. Rinse the cooking chamber thoroughly.
5. Examine the cooking chamber for any remaining calcium deposits.
6. If necessary, repeat the decalcification.
7. Open the cooking chamber door and leave it ajar until the unit is used again.
 - ↳ This extends the service life of the door seal.
 - ↳ No moisture builds up in the cooking chamber.

6.11 Cleaning the cooking chamber automatically with WaveClean

CAUTION

Risk of chemical burns

Keep the cooking chamber door closed during the cleaning cycle.

INFORMATION

Note regarding cleaning agents

The use of unsuitable cleaning agents normally will damage the units. Henny Penny has made a great effort to offer a cleaning agent that provides exceptional cleaning but does not attack or damage the hot air steamer. We thus recommend that only our own cleaning agent be used. Henny Penny assumes no responsibility or liability for damage caused by unsuitable cleaning agents. Claims against Henny Penny cannot be justified on the basis of such damage, not even in the context of warranty or guarantee.

INFORMATION

Cooling the temperature sensor in order to start the cleaning process sooner is not allowed. The whole cooking chamber must be cooled down to 60 °C (140 °F) for effective cleaning.

INFORMATION

Depending on the cleaning level selected, the fan may be idle for up to 60 minutes. This does not mean that cleaning has been interrupted; it is a normal part of the cleaning program.

INFORMATION

Forced rinse

Automatic forced rinse is triggered in the following situations.

- Cleaning is canceled manually. Canceling within the first 10 minutes of cleaning does not trigger an automatic forced rinse.
-

- Cleaning is canceled automatically in the event of a fault.
- The combi-steamer is switched off and then back on during cleaning. An automatic forced rinse begins when the unit is switched back on.

INFORMATION

If the automatic forced rinse is canceled, it starts again from the beginning.
It is not possible to start a cooking program before the forced rinse run to completion.

6.11.1 Preparing for cleaning

NOTICE

Risk of property damage from improper cleaning

- Do not clean the unit with a high-pressure cleaner or water jet.

Prerequisite GN containers, baking sheets and grates removed from the cooking chamber

1. Remove any food remains from the cooking chamber.
↳ The drainage sieve is not obstructed.
2. Leave only the hang-in frame in the cooking chamber in tabletop units and the tray trolley in the cooking zone in pedestal units.
3. Close the cooking chamber door.

6.11.2 Selecting the cleaning level

INFORMATION

Despite different cleaning durations, all cleaning steps require the same amount of water.

Tip

In the case of automatic cleaning overnight, we recommend the "medium" or "intensive" cleaning level. This ensures adequate drying.

Prerequisite Unit is on
Main menu is displayed

1. Tap Unit function.
2. Tap the *WaveClean* symbol.
3. Selecting the cleaning level.
↳ The *Operating instruction* window is displayed.
4. Tap the *Confirm* button.
↳ The *Select cleaning level* window is displayed.
5. Tap the "Start Stopp" button.
↳ If necessary, the cooking chamber is cooled down until the cleaning temperature of 60 °C (140 °F) is reached.

6.11.3 Inserting the cleaning cartridge

INFORMATION

Use only cleaning cartridges with an undamaged wax seal.

If the wax seal is damaged, the cleaner can enter the cleaning circuit prematurely or not dissolve completely, so that complete cleaning is no longer assured.

Insert the cleaning cartridges only when requested to do so.

INFORMATION

Never operate the unit in the automatic cleaning mode without a cleaning cartridge.

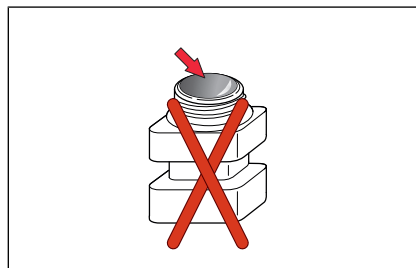

Image: Wax seal on the cleaning cartridge damaged

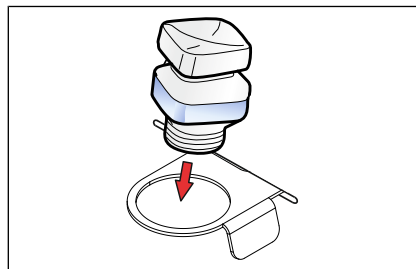

Image: Insert the cleaning cartridge in the holder

Prerequisite Cleaning cartridge sealed and undamaged

1. Open the cooking chamber door.
2. Open the lid of the cleaning cartridge.
3. Place the cleaning cartridge in the holder on the air diverter.
4. Close the cooking chamber door.

6.11.4 Starting automatic cleaning

INFORMATION

Never operate the unit in the automatic cleaning mode without a cleaning cartridge.

- Requirements** Water connection is open
 The unit is on
 Cleaning level selected
 Cleaning cartridge inserted
 Cooking zone temperature at 60 °C (140 °F)
- Tap the "START STOPP" button.
 ↳ The display shows the remaining time.

6.11.5 Canceling automatic cleaning

1. Tap the "Stopp" button.
 ↳ Automatic cleaning is canceled.
 ↳ Automatic rinsing starts and cannot be canceled.
 ↳ Upon completion, a prompt appears to remove the cleaning cartridge.
2. Remove the cleaning cartridge.

6.11.6 Ending automatic cleaning

CAUTION

Risk of chemical burns

Dripping liquid can contain chemically aggressive components; it is thus necessary to take appropriate protective measures.

Prerequisite Automatic rinsing has stopped after the cleaning program was cancelled or the cleaning time has elapsed

1. Open cooking chamber door.
2. Remove the empty cleaning cartridge.
3. Use the hand shower to thoroughly rinse away any remaining cleaner or rinse aid.
4. Close the cooking chamber door.
 ↳ After the cooking chamber door is closed, the cleaning program is completed.
5. Use a gentle stream of water to flush away any drops of cleaning water that have collected on the floor in front of the unit.
6. Open the cooking chamber door and leave it ajar until the unit is used again.
 ↳ This extends the service life of the door seal.
 ↳ No moisture builds up in the cooking chamber.

6.12 Cleaning the cooking chamber manually

6.12.1 Preparing the cooking chamber

NOTICE

Risk of property damage from improper cleaning

- Do not clean the unit with a high-pressure cleaner or water jet.

Prerequisite GN containers, baking sheets and grates removed from the cooking chamber

1. Remove any food remains from the cooking chamber.
↳ The drainage sieve is not obstructed.
2. Leave only the support rack in the cooking chamber.
3. Close the cooking chamber door.

6.12.2 Starting the cleaning program

Prerequisite Unit is on

→ Tap Manual cleaning.

6.12.3 Spraying the cleaner

⚠ CAUTION

Dangerous situation

Failure to observe precautions can result in slight to moderately severe injuries.

- Wear protective clothing.
- Wear breathing protection.

NOTICE

Risk of property damage from exceeding the recommended acting time of the cleaner

- Do not allow the cleaner to act longer than specified by the program.

1. The menu field displays the instruction "Spray cleaner"
2. Put on protective clothing, safety goggles and protective gloves
3. Open cooking chamber door.
4. Spray the cooking chamber, heat register and fan wheel with cleaner.

6.12.4 Allowing the cleaner to act

→ Close the cooking chamber door.

↳ The acting time starts.

↳ The display shows the remaining time until the "Flush cooking chamber" stage.

6.12.5 Starting cleaning

- The acting time has elapsed, the cleaning process starts automatically.
 - ↳ The cooking chamber is heated.
 - ↳ The display shows the remaining time.

6.12.6 Drying the cooking chamber

Prerequisite Cooking chamber door closed

1. The drying process starts automatically.

INFORMATION

The cooking chamber is heated.

2. After the end of the drying process, a signal sounds.
 - ↳ "End" appears on the display.
3. Open the cooking chamber door and leave it ajar until the unit is used again.
 - ↳ This extends the service life of the door seal.
 - ↳ No moisture builds up in the cooking chamber.

6.13 Inspecting the unit

6.13.1 Performing a visual inspection

NOTICE

Risk of property damage from improper inspection

- Inspect in accordance with the inspection intervals.
- Have inspections performed by a capable user.
- In the event of damage or signs of wear, contact customer service immediately and stop using the unit.

Prerequisite Unit disconnected from the electric supply mains
 Unit empty and cleaned
 Cooking chamber door opened completely

- Inspect housing, cooking chamber door and cooking chamber yearly for deformation and damage.
- ↳ Visual inspection has been performed.

7 Troubleshooting

7.1 Emergency operation

In order to allow limited use in case of error, the unit has several different emergency programs. Emergency operation is activated automatically and displayed. After elimination of the error indicated, the controls switch back into normal operation automatically. A reset is not necessary.

INFORMATION

Emergency programs handle the limited further operation of the appliance until servicing. Deviating cooking results and temperature deviations are possible.

7.2 Nameplate

When contacting customer service, please always provide the following data from the nameplate:

Serial number (SN)	
Type number (TYP)	

7.3 Cause of error and remedy

If a fault occurs during operation, the fault number and fault message are displayed.

Error no.	Fault message displayed	Description	Action
694 695	<ul style="list-style-type: none"> Cooking sensor defective 	The internal core temperature sensor assumes the function of the defective cooking chamber sensor.	<ul style="list-style-type: none"> Insert the internal core temperature sensor into its holder. This can lead to a different cooking result. Contact customer service.
699 700 714 716	<ul style="list-style-type: none"> Internal core temperature sensor defective 	The internal core temperature sensor in the cooking chamber is deactivated.	<ul style="list-style-type: none"> If possible, use the external core temperature sensor (optional). Select a different cooking program. Contact customer service.

Error no.	Fault message displayed	Description	Action
710	<ul style="list-style-type: none"> • Vapour sensor defective 	Steam elimination is now controlled solely by the software. This results in higher water consumption.	<ul style="list-style-type: none"> • Contact Customer service
	<ul style="list-style-type: none"> • Water pressure too low 	As continuous fault message	<ul style="list-style-type: none"> • Open the water valve • If water valve not closed, contact customer service
	<ul style="list-style-type: none"> • Water pressure too low 	As sporadic fault message	<ul style="list-style-type: none"> • Activate fewer appliances simultaneously in the kitchen. • Contact Customer service
	<ul style="list-style-type: none"> • No water in the siphon 	The siphon is insufficiently filled with water.	<ul style="list-style-type: none"> • Open the water valve • 2 l (0,53 gal) Pour water into the cooking chamber • If the fault message does not disappear, contact customer service
	<ul style="list-style-type: none"> • Unit restarted after power failure 	If there was no power failure in the kitchen, an operating error may be involved. For instance, unintentionally switching on and off while a cooking program was running.	<ul style="list-style-type: none"> • Power failure < 1 minute • Confirm the power failure message • Continue the cooking program • No cleaning necessary • Power failure > 1 minute • Cooking program cancelled • Run the cleaning cycle
	<ul style="list-style-type: none"> • WaveClean cancelled 	<ul style="list-style-type: none"> • Heed the explanations and instructions in the "Automatic cleaning (WaveClean)" chapter 	

8 Carrying out maintenance

The manufacturer recommends professional cleaning of the unit by trained technical personnel in 12-month intervals. With a heavier use, a maintenance interval of 6 months is recommended.

9 Disposing of unit in an environmentally responsible manner

The unit has been designed to provide a lifetime of 10 years with average use.

Do not dispose of unit or the unit's components together with non-recyclable waste. If the unit is disposed of together with non-recyclable waste or treated improperly, toxic substances contained in the unit can damage health and pollute the environment.

Dispose of the unit in accordance with local regulations for used appliances. Clarify any open questions with the responsible agencies (for instance, solid waste management).

Unit In addition to valuable materials, used electrical and electronic equipment also contains harmful substances that were needed for their operation and safety.

Cleaning agents Dispose of leftover cleaning agents and cleaning agent containers in accordance with the information provided by the cleaning agent's manufacturer. Observe applicable regional regulations.

Keyword index

- A**
Automatic cooking (autoChef)
 Deleting a cooking program 78
 Exporting and importing a cooking program ..
 79
 Finding and opening a cooking program .. 75
 Importing a cooking program 79
 Modifying the cooking program..... 77
Automatic forced rinse..... 88
- C**
Changing basic settings 33
ChefsHelp..... 20
Clean
 Lock touchscreen..... 83
Cleaning
 Automatic cleaning (WaveClean) 89
 Cleaning cartridge (WaveClean)Cleaning 90
 Manual cleaning..... 92
ClimaSelect plus..... 21
Combisteamng 18
Continue cooking..... 20
Core temperature
 Core temperature measurement..... 21
Core temperature measurement
 4-point core temperature sensor
 measurement 65
 Setting the core temperature 48
 Standard setting value 28
- D**
Delta-T cooking 18
DynaSteam² 21
- F**
FamilyMix 20
- H**
HACCP 64
Hot air 18
- I**
Idle time 20
Images
 Importing images 41
Inhibit operation 37
- L**
Low-temperature cooking 18
- M**
Main menu..... 22, 32
Manual cooking 67
 Creating a cooling program step..... 67
 Creating and saving a cooking program ... 70
 Exporting a cooking program..... 74
- P**
PerfectHOLD 19
- Q**
QualityControl..... 20
- R**
RackControl..... 19
Ready2Cook..... 19
Recipes
 Import recipes 42
Regeneration 18
Retrieving unit information..... 35
- S**
SES 19
Setting favorites..... 37
Setting the cooking time 44
Setting the fan 49
Settings
 Setting the date and time 35
Start time selection 19
Steaming 18
 Manual 20
- T**
Temperature
 Setting the cooking temperature 43
 Standard setting value 27
Time2Serve 21
- V**
Video
 Delete video 81
 Import video 40



Henny Penny Corporation
P.O.Box 60
Eaton, OH 45320
USA

Phone +1 937 456-8400
Fax +1 937 456-8402

Toll free in USA
Phone +1 937 417-8417
Fax +1 937 417-8434

www.hennypenny.com

