

Operating manual

SmartCombi

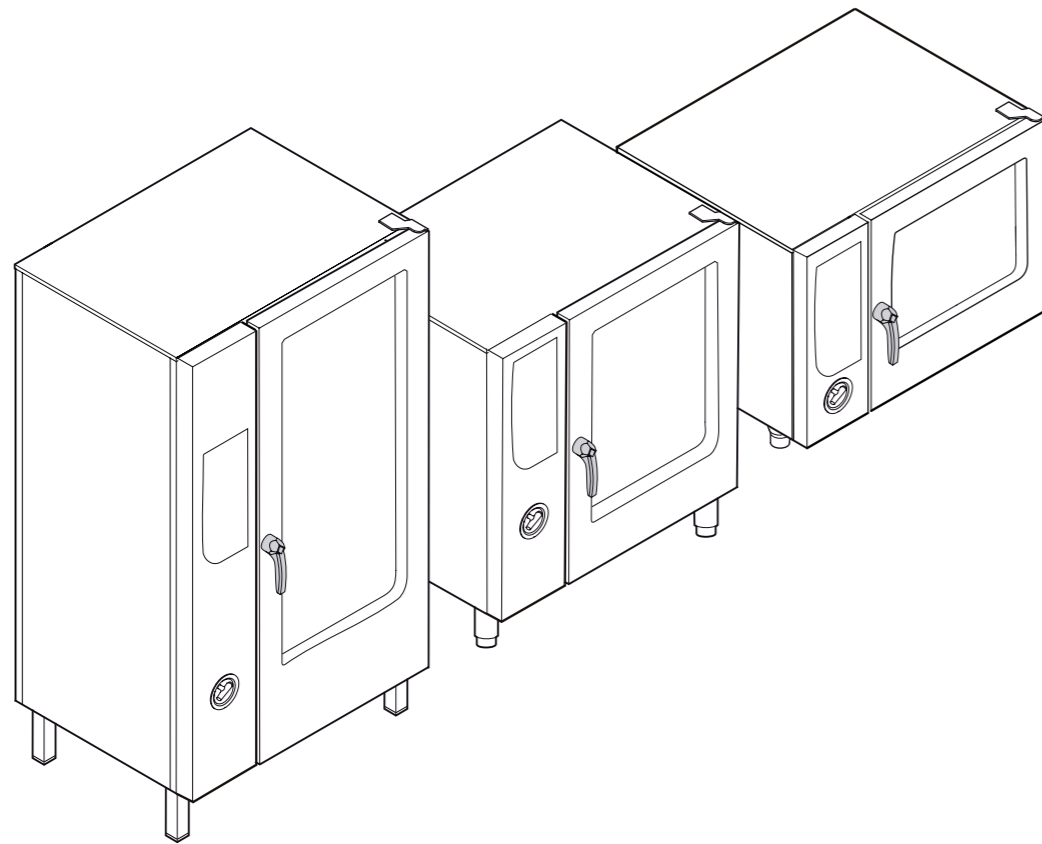

Open out the cover page to see the controls.

Version	Type no. (electric)	Type no. (gas)	Size
SmartCombi	ESC61XXXX	GSC61XXXX	615
SmartCombi	ESC62XXXX	GSC62XXXX	620
SmartCombi	ESC11XXXX	GSC11XXXX	115
SmartCombi	ESC12XXXX	GSC12XXXX	120
SmartCombi	ESC21XXXX	GSC21XXXX	215
SmartCombi	ESC22XXXX	GSC22XXXX	220

Controls

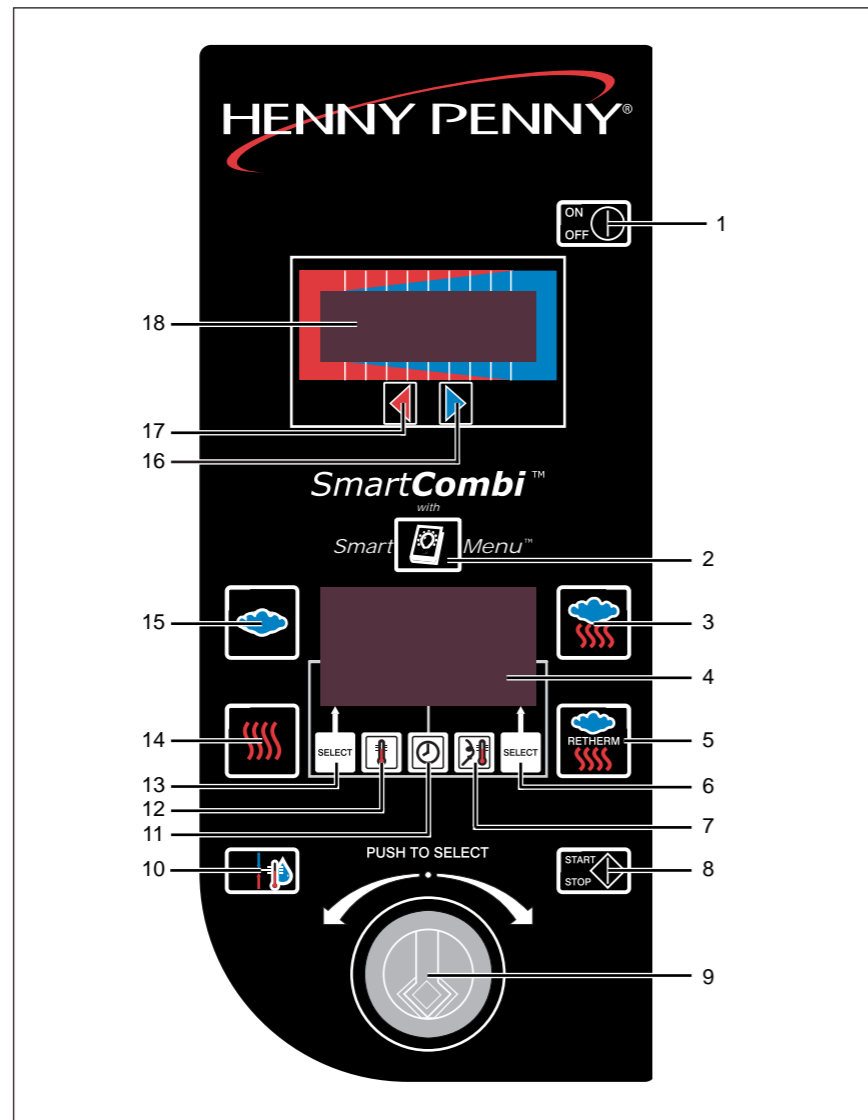

- | | |
|------------------------------------|---|
| 1 "On/Off" button | 10 "Ready2Cook" button |
| 2 "SmartMenu" button | 11 "Cooking time" button |
| 3 "Combisteam" cooking mode button | 12 "Cooking temperature" button |
| 4 Display | 13 Multi-function select button |
| 5 "Perfection" cooking mode button | 14 "Convection" cooking mode button |
| 6 Multi-function select button | 15 "Steaming" cooking mode button |
| 7 "Core temperature" button | 16 Set button for the AtmosControl climate control system |
| 8 "Start/Stop" button | 17 Set button for the AtmosControl climate control system |
| 9 "CombiDial" | 18 ClimaMonitor |

1	Introduction	7
1.1	Intended use	7
1.2	About this operating manual	7
1.3	Warnings	8
1.4	Warranty and liability	8
1.5	Signs and symbols	9
2	Safety information	10
3	Construction and function	14
3.1	Description of the unit	14
3.2	Description of the controls	17
3.3	Operating modes	17
3.4	SmartMenu (automatic cooking)	18
3.5	Manual cooking	18
3.5.1	Steaming	18
3.5.2	Combisteamming	20
3.5.3	Convection	20
3.5.4	Perfection (climate and regeneration)	21
3.5.5	Delta-T cooking	22
3.5.6	Low temperature cooking	24
3.6	Advanced cooking functions	26
3.6.1	Programmable steaming	26
3.6.2	Manual steaming	26
3.6.3	Rest period	26
3.6.4	Preset start time	26
3.6.5	Ready2Cook (prepare for cooking)	27
3.6.6	RackControl	27
3.6.7	Reduced heat output	27
3.7	Add functions	28
3.7.1	SES steam exhaust system	28
3.7.2	Cycle fan operation	28
3.7.3	Reduced fan speed	28
3.7.4	End of step signal	29
3.8	AtmosControl climate control system	29
3.9	Core temperature measurement	29
3.10	HACCP log	29
3.11	WaveClean automatic cleaning system	31

3.12	USB interface	31
4	Operation	32
4.1	Opening and closing cooking chamber door (tabletop units)	32
4.1.1	Opening the cooking chamber door	32
4.1.2	Closing the cooking chamber door	32
4.2	Opening and closing cooking chamber door (floor standing units)	33
4.2.1	Opening the cooking chamber door	33
4.2.2	Closing the cooking chamber door	33
4.3	Filling and emptying the unit (tabletop unit)	34
4.3.1	Filling and emptying the unit (with loading trolley)	34
4.3.2	Filling and emptying the unit (without loading trolley)	35
4.4	Filling and emptying the unit (floor standing units)	36
4.5	Switch on/switch off unit	36
4.5.1	Switching on	36
4.5.2	Switching off	36
4.6	Working with the CombiDial	37
4.7	Basic functions	37
4.7.1	Changing the language	37
4.7.2	Call up the setup menu and change parameters	37
4.7.3	Displaying actual temperature values	38
4.7.4	Set the cooking temperature	38
4.7.5	Setting the cooking time	38
4.7.6	AtmosControl climate control system (set chamber humidity)	39
4.7.7	Measuring the core temperature	39
4.7.8	Connecting the USB memory stick	40
4.7.9	Saving the HACCP log	40
4.7.10	Saving error messages	41
4.8	SmartMenu (automatic cooking)	41
4.8.1	Selecting the cooking program	41
4.8.2	Starting the cooking program	42
4.8.3	Ending the cooking program	43
4.8.4	Display last program	43
4.8.5	Changing the cooking program during operation	43
4.8.6	Save changed program	44
4.8.7	Create your own cooking programs	44
4.8.8	Entering a cooking program (example)	45
4.8.9	Copying a cooking program	45

4.8.10	Locking and releasing the SmartMenu program memory	46
4.8.11	Saving SmartMenu cooking programs	47
4.8.12	Loading SmartMenu cooking programs	47
4.9	Manual cooking	48
4.9.1	Starting the steaming process	48
4.9.2	Start Combisteaming	48
4.9.3	Starting the convection cooking mode	49
4.9.4	Starting perfection mode (climate and regeneration)	49
4.9.5	Start Delta-T cooking	50
4.9.6	Starting low temperature cooking	50
4.10	Advanced cooking functions	51
4.10.1	Programmable steaming	51
4.10.2	Manual steaming	52
4.10.3	Setting the rest period	52
4.10.4	Setting the preset start time	53
4.10.5	Starting Ready2Cook (prepare for cooking)	53
4.10.6	Working with RackControl	54
4.10.7	Reduced heat output	55
4.11	Add functions	56
4.11.1	Activate/deactivate add functions	56
4.11.2	Modify add function	56
4.11.3	Reducing the fan speed	56
4.11.4	Activating the end-of-step signal	56
4.12	Changing standard settings	57
4.12.1	Set service interval water volume	57
4.13	Standard settings	58
5	Cleaning	62
5.1	Automatic cleaning WaveClean	62
5.1.1	Preparing the cooking chamber	62
5.1.2	Selecting the WaveClean level	62
5.1.3	Using the WaveClean cartridge	63
5.1.4	Start WaveClean	64
5.1.5	Ending WaveClean	64
5.1.6	Cancelling WaveClean	64
5.1.7	WaveClean faults	65
5.2	System-supported manual cleaning	66
5.2.1	Preparing the cooking chamber	66
5.2.2	Start cleaning program	66
5.2.3	Spraying cleaning solution	67

5.2.4	Let the cleaner work	67
5.2.5	Cleaning	67
5.2.6	Rinsing out	68
5.2.7	Cleaning the door seal	68
5.2.8	Drying	68
5.3	General cleaning	69
5.3.1	Cleaning the outside of the housing	69
5.3.2	Cleaning the cooking chamber	69
5.3.3	Cleaning the door seal	69
5.3.4	Cleaning the cooking chamber door	70
5.3.5	Cleaning the steam outlet port	71
5.3.6	Descaling	71
5.4	Removing the ventilation plate	72
5.4.1	Removing the ventilation plate (table top models)	72
5.4.2	Removing the ventilation plate (floor standing units)	72
6	Faults	74
6.1	Correcting faults	74
6.2	Resetting the control electronics	74
6.3	Cause of errors and troubleshooting	75
7	Limited Warranty	77

1 Introduction

1.1 Intended use

Henny Penny combisteamers are solely intended to be used for commercial purposes, especially in commercial kitchens.

The unit may only be used for cooking food and only with the correct racks, containers, baking sheets, rack trolleys and slide-in units.

The unit may only be used with the purest quality drinking water for producing steam; if necessary, in combination with a water preparation system.

It is not permitted to use the unit for the following purposes, among others:

- As a dishwasher
- As a storage container
- As a smoking oven
- Drying towels, paper or dishes
- Heating acids, brines or other chemicals
- Heating closed containers (e.g. tinned food)
- Heating inflammable liquids
- Melting fats or salts
- Heating rooms
- Deep frying
- Cleaning air filters
- Operation without slide-in rails/trolley

1.2 About this operating manual

This operating manual is part of the equipment and contains information required by the persons operating the unit to enable them to operate it safely, for cleaning and looking after the unit and for handling faults.

- The employees engaged to perform any tasks with the unit must have read the operating manual, especially the section “Safety information”, before beginning work.
- Keep this operating manual stored safely during the life of the unit.
- Make sure that this operating manual is constantly available for the staff at the place where the unit is used.
- Supply this operating manual to any subsequent owner or user of the unit.
- Include any supplements received from the manufacturer.
- Supplement the instructions, including supervisory or notification requirements, to take account of special operational circumstances e.g. work organisation, workflows or deployed staff.

- Target group**
- This operating manual is intended for employees who are responsible for operating, cleaning and looking after the unit as well as handling faults.
 - Repairs to the unit may only be carried out by specially trained technical staff.
 - Adults may not use the unit without supervision if
 - they are unable to do so due to their physical, sensory or mental capabilities,
 - they do not have the knowledge and experience required to operate the unit safely and in the manner intended.

1.3 Warnings

Warnings are indicated with a pictogram and a signal word.

The type and source of the risk as well as the consequences are described together with instructions for avoiding the danger. The meanings of the pictograms and signal words used are explained in section “Signs and symbols” (see [Chapter “Signs and symbols”, Page 9](#)).

1.4 Warranty and liability

The unit may not be modified or technically changed.

All guarantees or warranties cease to exist if technical changes are made. Furthermore, the safety of the unit is no longer guaranteed.

Claims for warranty or liability for damages to persons or property are excluded if they arise from one or more of the following causes:

- Improper use of the unit
- Incorrect installation, commissioning, operation or servicing of the unit
- Technical changes to the unit without the binding agreement of the manufacturer
- Use of spare parts or accessories not approved by Henny Penny
- Faults resulting from the failure to comply with these operating instructions

1.5 Signs and symbols

⚠ DANGER
<p>Imminent danger</p> <p>→ Non-compliance poses a threat of death or serious injury.</p>

⚠ WARNING
<p>Possible danger</p> <p>→ Non-compliance may pose a threat of death or serious injury.</p>

⚠ CAUTION
<p>Dangerous situation</p> <p>→ Non-compliance may result in slight injuries.</p>

CAUTION
<p>Dangerous situation</p> <p>→ Non-compliance may result in equipment damage.</p>

NOTICE
<p>Provides helpful information regarding use.</p>

Symbol	Meaning	Explanation
Requirements	Requirements	These must be fulfilled before you can follow the instructions.
→	Instruction, single step	An action is required here.
1. 2.	Instruction, multiple steps	Instructions must be followed in the order given.
On/Off	Control	Emphasises the name of the control

2 Safety information

Henny Penny appliances comply with the relevant safety standards. However, this does not exclude all possible dangers from arising, e.g. due to improper use.

Therefore, when installing and operating the unit, the operating personnel must be familiar with and observe local regulations, including BGR 111 "Working in catering kitchens".

The following safety measures must also be observed:

WARNING

Possible danger

→ Non-compliance may pose a threat of death or serious injury.

Electricity Risk of electric shock

- The cover of the housing may only be opened by specially trained technical staff.
- Repairs to the unit and to the mains power supply may only be carried out by specially trained technical staff.
- Disconnect the unit from the power supply before opening the cover of the housing.
- Do not operate the unit when the housing cover is open.

Gas Risk of explosion due to escaping gas

- If you smell gas:
 - Shut off the gas supply.
 - Ensure the area is adequately ventilated.
 - Do not activate any switches or use any electrical devices.
 - Do not use any open flames.
 - Notify the gas supply company and/or fire department. Use a telephone that is outside the installation site.
- In the event of fire
 - Shut off the gas supply.
 - Put out the fire with a fire extinguisher (class F or ABC powder) or fire blanket, never with water.

Soiled and greasy films Risk of fire due to soiled and greasy films

- Clean the unit after each use.
- Observe the instructions regarding cleaning.

Hot surfaces, steam and liquids**Risk of burns due to hot surfaces**

- Wear insulated protective gloves during operation.
- Always open the door of the cooking chamber wide enough and let it lock in place.
- Allow surfaces to cool before cleaning.
- Do not touch the interior of the unit or the inside of the cooking chamber door immediately after use.

Risk of burns due to hot steam

- Only open the door of the cooking chamber slightly at first to allow the steam to escape. Then open the door fully.
- Do not look into the steam outlet ports.
- Do not hold your hand over the steam outlet ports.

Risk of burns due to hot liquids

- Keep the door of the cooking chamber closed during the cleaning program.
- Do not insert containers with liquids to be cooked above eye-level.
- When transporting food items, use a heat-resistant container with handles and sealable lid.
- Secure loading/rack trolleys against tipping over.

Rotating fan**Risk of crushing fingers**

- Do not operate the unit without the ventilation plate.

Damaged windows**Risk of injury due to glass splinters**

- Do not operate the unit if the windows are damaged.
- Do not operate the unit if the cooking chamber lighting is defective.
- Dispose of foods spoiled by glass splinters.

Cleaning**Risk of burns caused by cleaning agents**

- Wear protective gloves and glasses when using caustic cleaning agents.
- Observe the information provided by the manufacturer of the cleaning agent.
- Store WaveClean and rinsing agent cartridges out of the reach of children.
- Observe the instructions for the storage of WaveClean and rinsing agent cartridges.

CAUTION

Dangerous situation

→ Non-compliance may result in equipment damage.

Core temperature measurement

Do not overheat the core temperature sensor

- Do not heat the core temperature sensor with a lighter or similar object.

Incorrect handling

Equipment damage due to incorrect handling

- To avoid damaging the electronics, do not operate the unit if the controls are damaged.
- To avoid moisture penetrating the unit, do not operate if the door seals are damaged.

Cleaning

Equipment damage due to incorrect cleaning

- Do not cool the cooking chamber abruptly after use (e.g. with a hand-held rinsing head).
- Do not clean the unit with a high-pressure cleaner.
- Do not clean the surfaces with abrasive cleaners, scouring pads or chemically aggressive cleaners.
- Observe the reaction times for cleaning agents.
- Clean the unit regularly.
- Keep the cooking chamber free of scale.
- For “WaveClean” automatic cleaning, only use the two-in-one original cartridges.
- Remove all GN containers and accessories from the cooking chamber before cleaning.

Improper use

Damage to equipment due to improper use

- Do not operate the unit at continually high temperatures.
- Do not operate the unit at temperatures below 4 °C (39.2 °F).
- Remove the core temperature sensor before removing the food item.
- Replace the core temperature sensor back in its holder after use.
- Only connect USB memory sticks based on flash memory. Do not connect USB printers, external hard disks, WLAN, UMTS or Bluetooth adapters or any other USB devices.
- Do not connect PCs or notebooks.
- Do not use force to insert USB memory sticks.
- Insert the USB memory stick before reading/writing data and only remove it once the data has been completely transferred.

NOTICE

Provides helpful information regarding use.

Handling foodstuffs Provisions governing foodstuffs

- For the function “Preset start time”, observe the provisions regarding foodstuffs.

3 Construction and function

3.1 Description of the unit

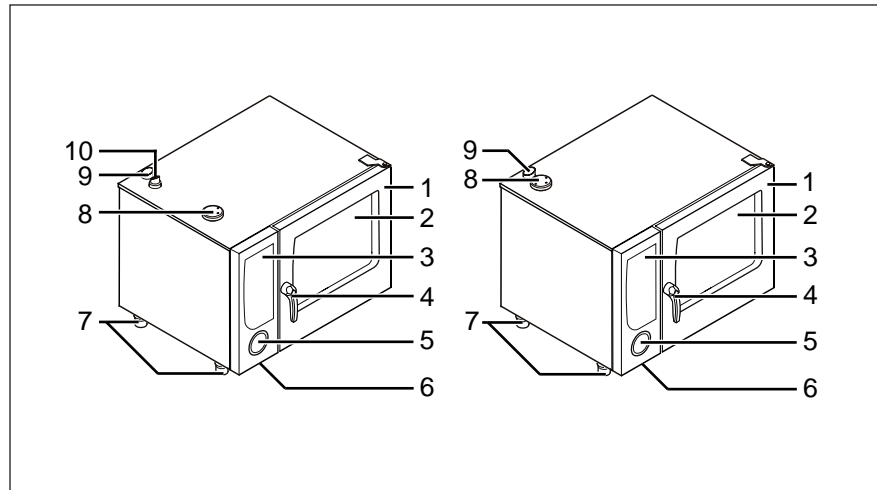

Figure 1: Sizes 615 and 620, left: gas, right: electric

- | | | | |
|---|------------------------|----|---|
| 1 | Cooking chamber door | 6 | Data interface (concealed) |
| 2 | Insulated window | 7 | Height-adjustable feet |
| 3 | Controls | 8 | Air intake port for the cooking chamber |
| 4 | Door handle | 9 | Steam outlet port |
| 5 | Hand-held rinsing head | 10 | Flue outlet |

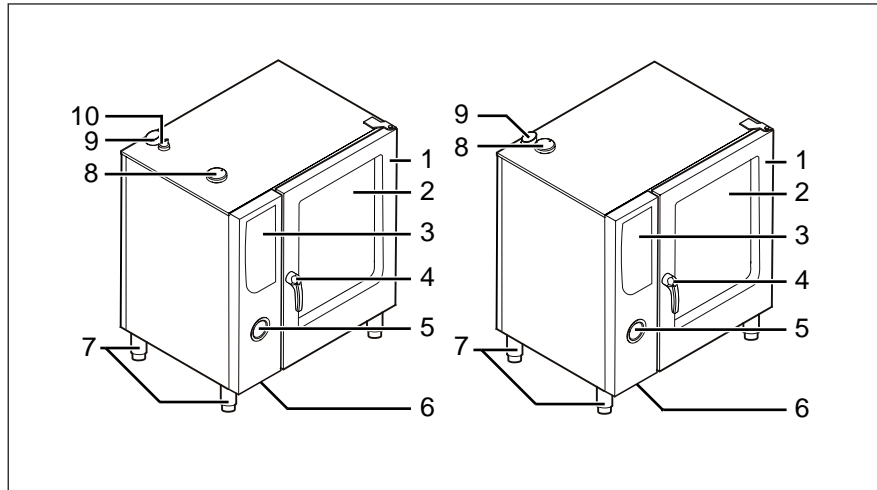

Figure 2: Sizes 115 and 120, left: gas, right: electric

- | | | | |
|---|------------------------|----|---|
| 1 | Cooking chamber door | 6 | Data interface (concealed) |
| 2 | Insulated window | 7 | Height-adjustable feet |
| 3 | Controls | 8 | Air intake port for the cooking chamber |
| 4 | Door handle | 9 | Steam outlet port |
| 5 | Hand-held rinsing head | 10 | Flue outlet |

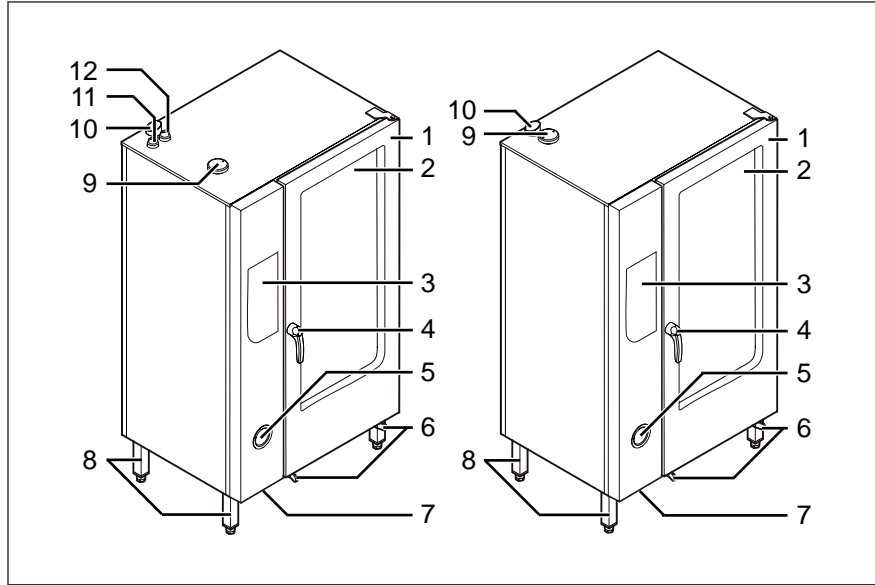

Figure 3: Sizes 215 and 220, left: gas, right: electric

- | | | | |
|---|------------------------|----|---|
| 1 | Cooking chamber door | 7 | Data interface (concealed) |
| 2 | Insulated window | 8 | Height-adjustable feet |
| 3 | Controls | 9 | Air intake port for the cooking chamber |
| 4 | Door handle | 10 | Steam outlet port |
| 5 | Hand-held rinsing head | 11 | Flue outlet (lower burner) |
| 6 | Rails for rack trolley | 12 | Flue outlet (upper burner) |

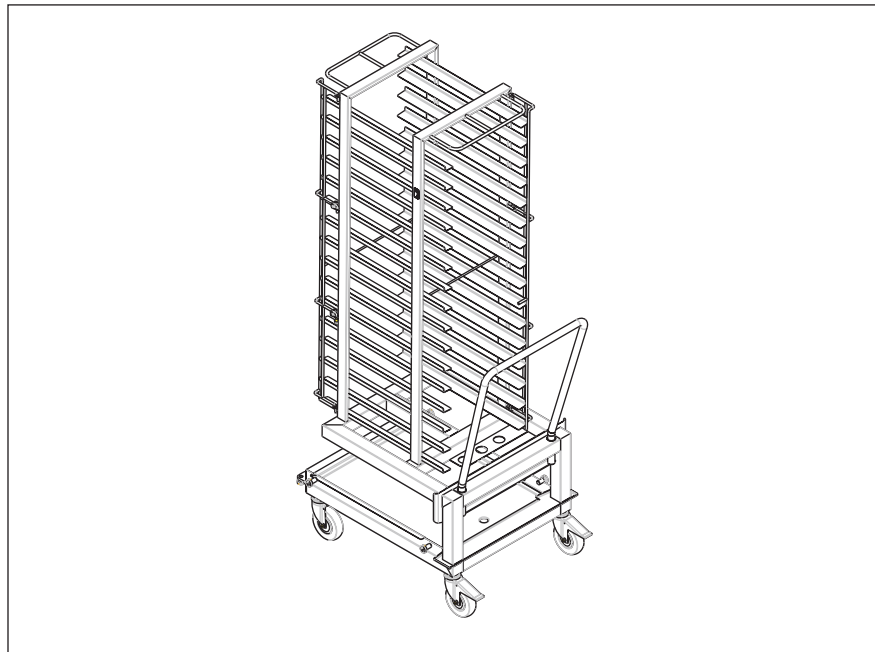

Figure 4: Rack trolley (for sizes 215 and 220)

3.2 Description of the controls

NOTICE

Open out the front cover to see the controls.

Control	Description
ClimaMonitor	Display for the SmartMenu cooking categories Chamber humidity display
Anzeige	Display of temperatures and cooking times Menu navigation display Selection of SmartMenu cooking categories
Cooking mode button "Combisteaming"	Call up "Combisteaming" cooking mode
Cooking mode button "Perfection"	Call up "Perfection" (climate and regeneration) cooking mode
Cooking mode button "Convection"	Call up "Convection" cooking mode
Cooking mode button "Steaming"	Call up "Steaming" cooking mode
Multi-function select button	Call up various functions The multi-function display (4) shows the respectively assigned function
Set button for the AtmosControl climate control system	Increase or decrease cooking chamber humidity
"On/Off" button	Switch on/off
"SmartMenu" button	Call up SmartMenu (automatic cooking)
"Start/Stop" button	Start/stop operation
"Core temperature measurement" button	Call up the "core temperature measurement" function
"Ready2Cook" button	Start the "Ready2Cook" function (prepare for cooking)
"Cooking time" button	Display and change cooking time
"Cooking temperature" button	Display and change cooking temperature
"CombiDial"	Navigation in menus Selection of values

3.3 Operating modes

The unit has two operating modes:

- SmartMenu (automatic cooking)
- Manual cooking

You can use different cooking methods in both of these operating modes.

Advanced cooking functions and add functions allow you to adjust the cooking processes individually.

- | | |
|-----------------------------------|--|
| Cooking modes | <ul style="list-style-type: none"> • Steaming • Combisteaming • Convection • Perfection (climate and regeneration) • Delta-T cooking • Low temperature cooking |
| Advanced cooking functions | <ul style="list-style-type: none"> • Programmable steaming • Manual steaming • Rest period • Preset start time • Ready2Cook (prepare cooking) • Reduced heat output • RackControl |
| Add functions | <ul style="list-style-type: none"> • SES steam exhaust system • Cycle fan operation • Reduced fan speed • End of step signal |

3.4 SmartMenu (automatic cooking)

The **SmartMenu** operating mode is the function for automatic cooking.

The SmartMenu cooking program was developed by Henny Penny chefs, however, it can be individually adapted. You can also create new SmartMenu programs.

3.5 Manual cooking

3.5.1 Steaming

With the **Steaming** cooking mode, you can blanch, steam, steep, boil, preserve and poach.

There are three steaming methods:

- Soft Steaming: 30 °C (86 °F) to 99 °C (210.2 °F)
 - Steaming: 100 °C (212 °F)
 - Express Steaming: 101 °C (213.8 °F) to 130 °C (266 °F)
- | | |
|-----------------|--|
| Benefits | <ul style="list-style-type: none"> • Fast production of dishes that are firm to the bite with a good colour and an intensive natural flavour. • Vitamins and minerals are retained. • Flavours are not transferred. The food retains its taste and aroma; mixed loads are possible. |
|-----------------|--|

- Less seasoning, fats and salt needed.
- Tips**
- Use perforated GN containers with a depth of 40–65 mm. These allow for short cooking times and avoid the food underneath being overcooked.
 - Break up lumps of ice when using frozen foodstuffs so that all the food will be heated evenly.
 - Chill vegetables quickly after steaming, add butter and season.
 - Use stock for vegetable bundles. Steam the vegetables in perforated GN containers and catch the stock in unperforated containers.
 - Steam long grain rice in unperforated containers.
Use 1½ parts of cold water or cold stock to 1 part of rice.
 - Steam hard wheat pasta in unperforated containers.
Use at least 5 parts of water for 1 part of pasta.
 - Steam large and small dumplings in perforated containers lined with baking paper.
Uncover immediately after cooking.
If necessary, keep them warm in water thickened with starch.
 - Sprinkle potatoes with fine grained salt and mix immediately before steaming.
Alternatively, place potatoes in salt water for 15 minutes.

Soft steaming

Steaming at temperatures between 30 °C (86 °F) and 99 °C (210.2 °F) is called **Soft steaming**.

You can use soft steaming to prepare dishes especially gently, to swell grains or to cook ham or sausages.

NOTICE

Cooking time is longer than with steaming or express steaming.

- Benefits**
- Less weight loss with meat and sausages.
 - Burst skin or gut is avoided when scalding or heating sausages.
 - Optimal food quality with delicate dishes such as terrines, jellies, flans, forcemeat dumplings, creme caramel or diet meals.
 - Good when using vacuum pouches with the sous vide process.
 - Egg white sets optimally thanks to the precise cooking temperature and doesn't run out of the food.
- Tips**
- Allow yeast doughs for bread, buns or pastries to rise at a temperature of 32 °C (89.6 °F).
 - When preparing poached trout, pour vinegar or wine over the fish.

Express steaming

Steaming at temperatures between 101 °C (213.8 °F) and 130 °C (266 °F) is called **Express steaming**.

Express steaming is suitable for foods that are not damaged easily such as jacket potatoes, beetroot, swede, pulses and cabbage.

Benefits The cooking time is reduced by about 10% as compared to the “Steaming” cooking mode.

- Tips**
- Set the cooking temperature between 105 °C (221 °F) and 110 °C (230 °F) for small loads.
 - If the unit is fully loaded, set the temperature between 110 °C (230 °F) and 130 °C (266 °F).

3.5.2 Combisteaming

The **Combisteaming** cooking mode is especially suitable for large roasting joints, casseroles and baked foods.

Benefits

- Optimal cooking chamber climate: the food does not dry out.
- Very fast cooking with minimum weight loss.
- Flavours are not transferred. The food retains its taste and aroma; mixed loads are possible.
- Foods such as yeast-based doughs rise optimally when baking.
- The steam closes the pores of large roasting joints immediately; searing is not necessary.

- Tips**
- Preheat unit for at least 10–15 minutes.
 - Reduce cooking temperature by 20–30 % compared to other cooking methods.
 - Food starts to brown at a cooking temperature of 120 °C (248 °F) and above.
The higher the set cooking temperature, the greater the food's weight loss but the more intensive the level of browning.
 - Place roast joints on racks. The pores of the joint will be closed from all sides, the joints do not have to be turned over.
 - Place a drip tray underneath the rack holding the joints for gravy or drippings. Place bones, roast vegetables and seasonings in the drip tray and pour water or stock over them.

3.5.3 Convection

The **Convection** cooking mode is especially suitable for products that don't need any additional humidity.

Benefits

- Large capacity.
- Even cooking results thanks to auto-reverse fan.

- Up to 95 % less fat required as with other cooking modes.

- Tips**
- Preheat unit for at least 10–15 minutes.
 - Food starts to brown at a cooking chamber temperature of 120 °C (248 °F) and above.
The higher the set cooking chamber temperature, the greater the food's weight loss but the more intensive the level of browning.
 - To produce crumbed dishes, use convenience products that are suitable for convection or crumbed products with browning fats.

3.5.4 Perfection (climate and regeneration)

With the **perfection** cooking mode, food can be regenerated in perfect quality on plates, platters or in GN containers.

- Benefits**
- Production and presentation of meals in quiet, slack periods: for banquets, you can regenerate as many plates as you wish on demand.
 - No loss of quality due to keeping prepared meals warm.
 - Optimal cooking chamber climate: the food does not dry out.
 - No condensation or dry edges on the plates.
- Tips**
- Preheat the unit then fill it quickly. In this way, the prewarmed air remains in the cooking chamber.
 - Large thick foods such as dumplings, roulades or casseroles need more time to regenerate: slice up thick components.
 - Individually arrange meal components evenly on the plate. Keep overlaps to a minimum and avoid different heights when arranging.
 - Only add sauces to the plates after regeneration is completed.
 - Place fish and meat on a raised bed so that they will be regenerated evenly and not stick to the plate.
 - Meat should be pre-cooked precisely to the minute if it is to be served medium after regenerating.
 - Season vegetables, rice and pasta and add fat before regenerating.
 - Use thermo covers and multiple banquet trolleys if the meals are to be transported over a long distance and for large banquets.
Warm the thermo covers before use.
Plates can only be kept warm for a maximum of 20 minutes.
Regenerate further batches during this time: in this way you can serve the meals to your guests at the same time.
 - To reduce cooking time, use portioned GN containers with lids for regenerating foods that are already portioned.
 - Regeneration time and regeneration temperature are dependent on the number of plates (see table “Plate capacities” and table “Regeneration temperatures and times”).

Size	Ø 26 cm (10.2")	Ø 28 cm (11")	Ø 32 cm (12.6")
615	30	24	22
620	30	24	22
115	50	40	40
120	50	40	40
215	100	80	80
220	120	120	80
	On slide-in racks (1/1 unit with special FlexiRack racks)		(plate rack frame or rack trolley)

Table 1: Plate capacities

Size	Regeneration temperature	Regeneration time
615	120 °C (248 °F)–130 °C (266 °F)	4–8 minutes
620	120 °C (248 °F)–130 °C (266 °F)	4–8 minutes
115	120 °C (248 °F)–130 °C (266 °F)	4–8 minutes
120	120 °C (248 °F)–130 °C (266 °F)	4–8 minutes
215	120 °C (248 °F)–130 °C (266 °F)	6–10 minutes
220	120 °C (248 °F)–130 °C (266 °F)	6–10 minutes

Table 2: Regeneration temperatures and times

3.5.5 Delta-T cooking

With **Delta-T cooking**, the cooking temperature depends on the core temperature of the food being cooked. Cooking times with Delta-T cooking are longer than with other cooking modes. You can make good use of slack periods by using the additional “preset start time” function.

With Delta-T cooking, the cooking temperature is always higher than the actual core temperature of the food being cooked. This difference is a previously set value (Delta-T value).

The formula is:

current core temperature + Delta-T value = cooking temperature

Since the core temperature of the food being cooked is needed, you must use the core temperature sensor with Delta-T cooking.

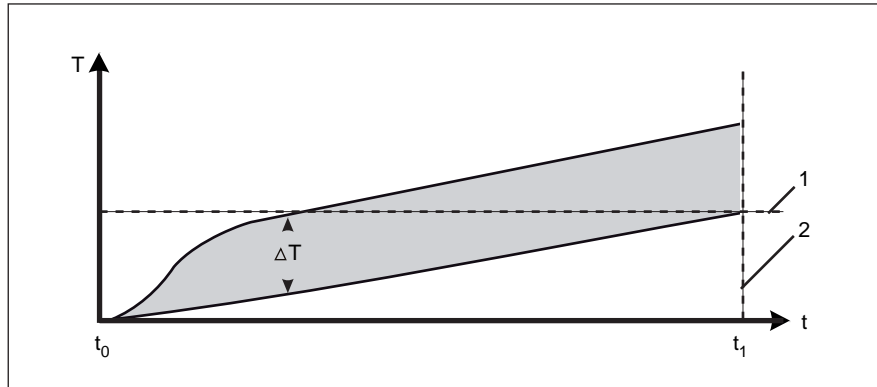

- t Time
- ΔT Delta-T value
- t_0 Cooking process begins
- 1 Target core temperature
- t_1 Cooking process ends
- 2 Target core temperature reached
- T Temperature

NOTICE

The higher the cooking temperature, the greater the food's weight loss but the more intensive the level of browning.
 The Delta-T value should always be at least 10 °C (50 °F) to avoid very long cooking times.

Cooking mode	Delta-T value	Target core temperature
Steaming	1 °C (33.8 °F)–31 °C (87.8 °F)	21 °C (69.8 °F)–99 °C (210.2 °F)
Combisteam	1 °C (33.8 °F)–151 °C (303.8 °F)	
Convection	1 °C (33.8 °F)–201 °C (393.8 °F)	

Table 3: Possible Delta-T values, depending on cooking mode

Large roasting joint	Delta-T value	Target core temperature
Roast beef	50 °C (122 °F)–55 °C (131 °F)	48 °C (118.4 °F)–58 °C (136.4 °F)
Fillet of beef	50 °C (122 °F)–60 °C (140 °F)	50 °C (122 °F)–60 °C (140 °F)
Roast veal	50 °C (122 °F)–70 °C (158 °F)	78 °C (172.4 °F)
Neck of pork	50 °C (122 °F)–70 °C (158 °F)	78 °C (172.4 °F)
Boiled ham	50 °C (122 °F)–60 °C (140 °F)	78 °C (172.4 °F)

Table 4: Recommended cooking temperatures for large roasting joints

3.5.6 Low temperature cooking

The **Low temperature cooking** mode is especially suitable for dark meats.

The raw weight of large roasting joints is almost fully retained thanks to the especially gentle cooking process (temperature range of 60 °C (140 °F)–100 °C (212 °F)); cooking losses are minimal.

To avoid crusts forming, the AtmosControl climate control system optimises the cooking chamber climate and the fan operates in cycle mode.

The benefits are:

- Reduced dehydration
- Even cooking
- Reduced crust formation
To obtain a crisp crust, sear with higher temperatures in a previous cooking step.
- Food can be kept warm without the surface becoming dry.

Low temperature cooking consists of two cooking steps: searing and the actual low-temperature cooking step.

NOTICE

The chamber temperature should be only slightly, but at least 5 °C (41 °F), above the target core temperature for the food to be cooked. If the difference between chamber temperature and core temperature is less than 5 °C (41 °F), it is possible that the target core temperature will not be reached.

The higher the cooking chamber temperature, the greater the food's cooking loss but the more intensive the level of browning.

Large roasting joint	Target core temperature	Chamber temperature	Cooking steps
Roast beef	55 °C (131 °F)	60 °C (140 °F)	1. Convection or combisteaming
Roast pork	75 °C (167 °F)	80 °C (176 °F)	
Roast veal	70 °C (158 °F)	75 °C (167 °F)	2. Low temperature cooking
Roast lamb	75 °C (167 °F)	80 °C (176 °F)	

Table 5: Recommended cooking temperatures for large roasting joints

Low temperature cooking is possible with or without core temperature measurement.

Low temperature cooking without core temperature measurement

When using low temperature cooking without core temperature measurement, the unit switches to low temperature cooking from the first cooking step as soon as the set cooking temperature is reached.

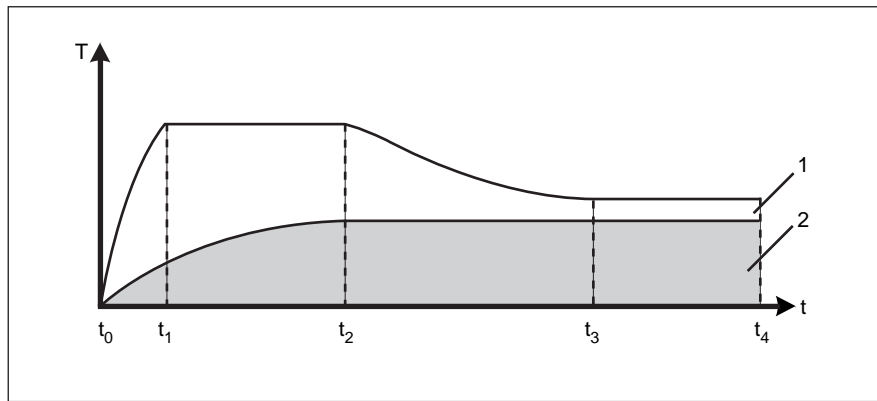

- 1 Chamber temperature
- 2 Cooking temperature
- t₀ Start
- t₁ Cooking chamber preheated
- t₂ 1st cooking step is ended
- t₃ 2nd cooking step is ended
- Food is ready to serve
- t₄ Maximum keep-warm period

Low temperature cooking with core temperature measurement

When using low temperature cooking with core temperature measurement, the unit switches to low temperature cooking from the first cooking step as soon as 80 % of the target core temperature is reached.

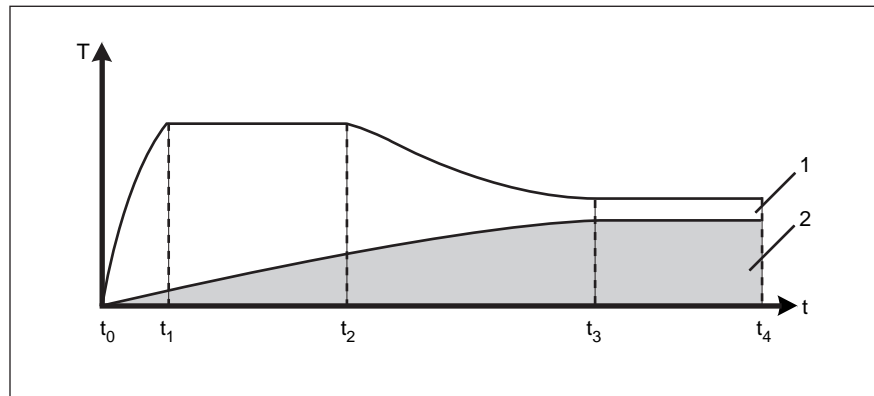

- | | | | |
|-------|---------------------------|-------|---|
| 1 | Chamber temperature | t_2 | 1st cooking step is ended |
| 2 | Core temperature | t_3 | 2nd cooking step is ended
Food is ready to serve |
| t_0 | Start | t_4 | Maximum keep-warm period |
| t_1 | Cooking chamber preheated | | |

3.6 Advanced cooking functions

3.6.1 Programmable steaming

The **programmable steaming** advanced function, is primarily used for baking dough that requires high levels of humidity in the cooking chamber before the baking phase starts.

3.6.2 Manual steaming

The **manual steaming** advanced cooking function lets you increase the humidity in the cooking chamber during operation.

Manual steaming is possible during operation with all cooking modes apart from steaming.

3.6.3 Rest period

With the **rest period** advanced cooking function, you can specify a period during which the fan is inactive.

This function is primarily used following programmed steaming to allow the steaming process to take effect.

3.6.4 Preset start time

The delay period before a program starts can be set with the **preset start time** function.

This lets you prepare the food, fill the unit and select the program that you want long before the cooking process is to begin.

Bottlenecks in producing and preparing dishes can be avoided in this way.

NOTICE

When using the preset start time feature, temperatures may occur in the cooking chamber that encourage the growth of harmful germs on the food to be cooked.

Observe the provisions governing foodstuffs.

3.6.5 Ready2Cook (prepare for cooking)

The right starting conditions are important for many programs (e. g. baking).

The advanced function **Ready2Cook** heats if the cooking chamber is too cold, cools if it is too hot and prepares the cooking climate for cooking.

NOTICE

The function can be started manually if necessary.

3.6.6 RackControl

If products with different cooking times, such as potatoes, cauliflower, peas, carrots and meat are to be cooked in one process or if the same meals are to be cooked at different times, the advanced function **RackControl** allows you to monitor up to 5 different cooking times.

When a cooking time is reached a short signal sounds and the food that is ready can be removed.

The cooking process is not interrupted by this (continuous operation).

“RackControl” is especially useful when regenerating plate dishes (“perfection”). The cooking times of several plate dishes can be monitored thanks to continuous operation.

3.6.7 Reduced heat output

The advanced cooking function **Reduced heat output** lowers the unit's output and enables output peaks in the power supply to be reduced.

- With tabletop units: A heating circuit is deactivated.
- With floor standing units: The lower chamber is turned off.

The function is suitable for:

- Cooking large roasting joints
- Low temperature cooking
- Cooking small loads

NOTICE

The reduced heat output increases the cooking time. For this reason, the function is **not** suitable for the “Perfection” (climate and regeneration) cooking mode.

3.7 Add functions

With the **add functions**, individual cooking steps can be adjusted to suit the food being cooked, in order to further optimise the cooking result.

The following add functions are available.

- SES steam exhaust system
- Cycle fan operation
- Reduced fan speed
- End of step signal

3.7.1 SES steam exhaust system

The unit is equipped with a safety steam extraction system. The **SES steam exhaust system** extracts the steam from the cooking chamber and condenses it at the end of the cooking time.

This avoids annoying clouds of steam escaping from the cooking chamber when opening the door after cooking has finished. The function has no effect on the cooking results.

The function is activated as default for all cooking programs longer than 6 minutes.

There is an add function allowing you to turn off the SES steam exhaust system.

3.7.2 Cycle fan operation

With the add function **cycle fan operation**, the fan operates in interval mode.

The function can be combined with the add function “reduced fan speed” in order to obtain 6 different fan speeds in the cooking chamber.

3.7.3 Reduced fan speed

The add function **reduced fan speed** lets you reduce the air circulation in the cooking chamber, in several stages, for dishes that are easily

damaged by a strong air flow, such as soufflé, meringue, sponges, cream puffs or flaky pastry.

3.7.4 End of step signal

With the add function **end of step signal**, a signal can be activated for each step of a multi-step cooking program. It signals that some action is to be taken e.g. "turn the roast".

A signal sounds for 10 seconds at the end of the cooking step (cooking time/target core temperature reached).

The next cooking step starts immediately. The next cooking step is not delayed because of the signal.

The end of step signal is activated as default for the last cooking step of a program.

3.8 AtmosControl climate control system

The humidity in the cooking chamber can be set from 0–100 % in 10 % steps with the active humidifying and dehumidifying function of the AtmosControl climate control system.

By setting a value under 100%, you can dehumidify the cooking chamber to achieve crisp cooking results for foods containing a lot of water. The excess steam is extracted from the cooking chamber and condensed.

3.9 Core temperature measurement

With **core temperature measurement**, the temperature in the inner of the food being cooked is measured with a sensor.

The cooking process is ended automatically as soon as the target core temperature is reached.

Core temperature measurement offers the following benefits:

- Energy and water consumption is lower
- No overcooking
- The food loses less weight
- High HACCP safety levels

3.10 HACCP log

Core temperature values are summarized in individual hourly blocks for the **HACCP log**. This data is then printed or transferred to a PC as a text file.

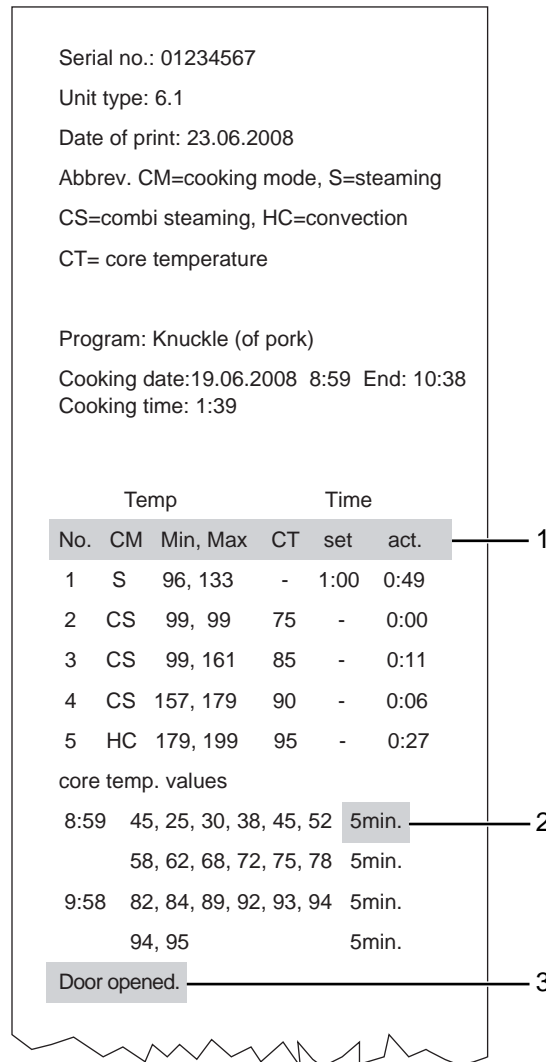

Figure 5: HACCP log (example)

- 1 See the following table for an explanation of the abbreviations
- 2 Query interval
- 3 Special event

Abbreviation	Explanation
No.	Number of the cooking step
CM	Cooking mode
Min	Minimum cooking temperature during this cooking step
Max	Maximum cooking temperature during this cooking step
CT	Target core temperature
Set	Set target time
Act.	Period over which the cooking temperature was maintained Time in which the target core temperature was reached

Table 6: HACCP log abbreviations

3.11 “WaveClean” automatic cleaning system

WaveClean is an automatic cleaning system, which cleans and rinses the cooking chamber automatically.

3.12 USB interface

NOTICE

You can find notes on operating the optional PC software on the software installation CD.

Henny Penny-combination steamers of the “SmartCombi” and “SpaceSaver PLUS” versions are equipped with a USB 2.0 interface.

Using a USB stick enables you to copy SmartMenu cooking programs you have made onto other devices. HACCP logs and error messages can also be archived in this way.

File names may only be up to 8 characters long followed by an extension. Longer file names are shortened and receive an additional serial number, e.g. “COOKBO~1.CSP” instead of “COOKBOOK.CSP”.

File names consist of the device no. and the file name extension:

- “HAC” for HACCP logs, e.g. “12345678.HAC”
- “CSP” for SmartMenu cooking programs, e.g. “12345678.CSP”
- “DIA” for error messages, e.g. “12345678.DIA”

4 Operation

4.1 Opening and closing cooking chamber door (tabletop units)

4.1.1 Opening the cooking chamber door

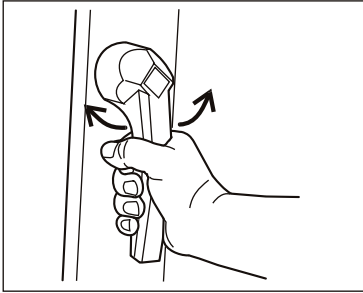

1. Turn the door handle to the side.
The cooking chamber door will open.

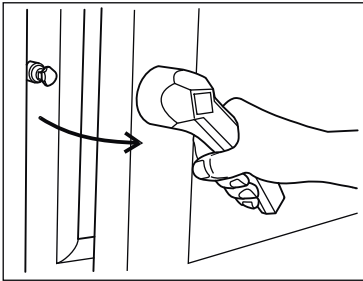

2. Open the chamber door wide.
If you let go of the door handle, it will return to the starting position.

4.1.2 Closing the cooking chamber door

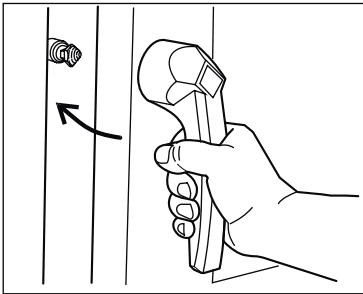

1. Turn the door handle downwards.
2. Push the door closed.
The door of the cooking chamber is closed.

4.2 Opening and closing cooking chamber door (floor standing units)

4.2.1 Opening the cooking chamber door

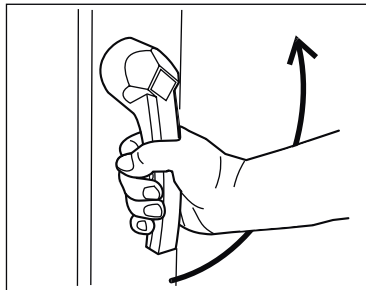

1. Turn door handle to horizontal.

The cooking chamber door will open but remain engaged.

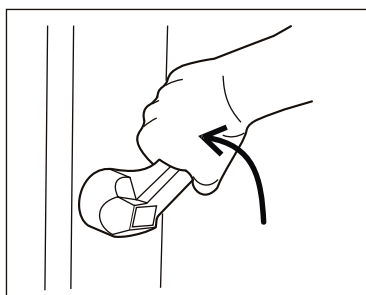

2. Turn the door handle further upwards.

The door will disengage.

3. Let the door handle spring back to horizontal and open the chamber door wide.

4.2.2 Closing the cooking chamber door

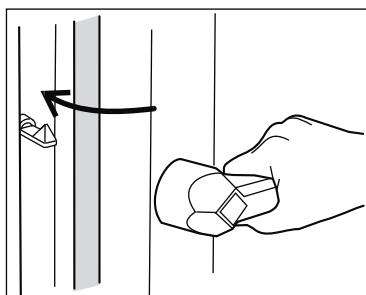

1. Position the door handle horizontally.

2. Close the door with the door handle horizontal.

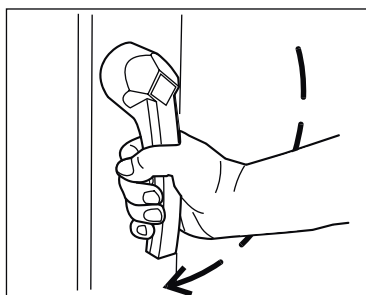

3. Turn the door handle downwards.

The door of the cooking chamber is closed.

4.3 Filling and emptying the unit (tabletop unit)

4.3.1 Filling and emptying the unit (with loading trolley)

Requirements Suspension frame is removed
Check that food racks are correctly positioned in the suspension frames

NOTICE

This section describes the process of filling/emptying with a loading trolley (optional accessory).

CAUTION

Risk of burns due to hot liquids

- Only use the correct racks: The racks must lie safely on the supporting brackets.
- Always push the racks into the U-shaped runners.
- Do not push in containers with liquids to be cooked above eye-level.

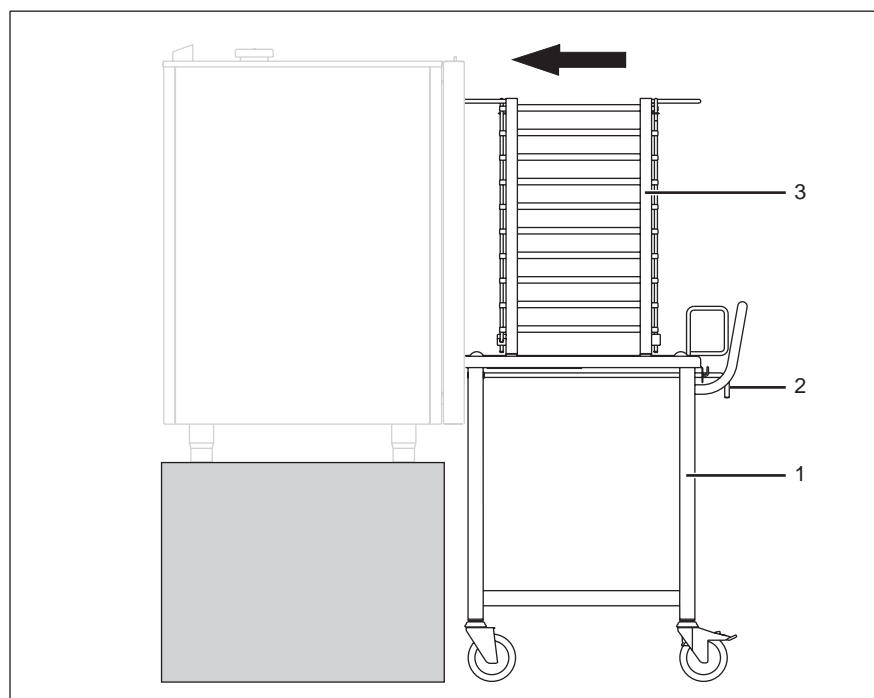

Figure 6: Filling/emptying with loading trolley

1. Open the chamber door.
 2. Mount the push-in frame on the bolts.
 3. Rotate the lever (2).
- The rack frame is secured against rolling off.

4. Push the loading trolley (1) close to the unit.
5. Rotate the lever (2).
Catch of the rack frame is released.
Loading trolley is secured against rolling away.
6. Check the catch of the loading trolley by pulling lightly.
7. Push in the rack frame (3) until the wheels click into the opening of the slide-in frame.
8. Rotate the lever (2).
The catch of the rack frame is released.
9. Push the loading trolley (1) away from the unit.
10. Close chamber door.
11. Start cooking process.
12. Open the chamber door and leave it slightly ajar until the next use.
This will increase the life of the door seal.
No moisture will build up in the chamber.
13. Empty completely after cooking is finished.
14. Remove all scraps of food from the outlet filter when emptying.

4.3.2 Filling and emptying the unit (without loading trolley)

CAUTION

Risk of burns due to hot liquids

- Only use the correct racks.
- Do not push in containers with liquids to be cooked above eye-level.

1. Open the chamber door.
2. Slide racks into the suspension frame.
3. Close chamber door.
4. Start cooking process.
5. Open the chamber door and leave it slightly ajar until the next use.
This will increase the life of the door seal.
No moisture will build up in the chamber.
6. Remove racks.
7. Remove all scraps of food from the outlet filter when emptying.

4.4 Filling and emptying the unit (floor standing units)

Requirements Check that food racks are correctly positioned in the trolley

⚠ CAUTION

Risk of burns due to hot liquids

- Only use the correct racks: The racks must lie safely on the supporting brackets.
- Always push the racks into the U-shaped runners.
- Do not insert containers with liquids to be cooked above eye-level.

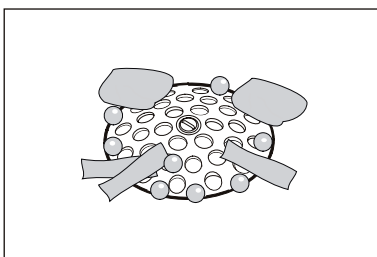

1. Load trolley.
2. Push in trolley completely.
3. Close the chamber door.
4. Start the cooking process.
5. Open the chamber door and leave it slightly ajar until the next use.

This will increase the life of the door seal.

No moisture will build up in the cooking chamber.

6. Empty completely after cooking is finished.
7. Remove all scraps of food from the drain sieve when emptying.

4.5 Switch on/switch off unit

4.5.1 Switching on

Requirements Supply lines have been checked.

→ Press On/Off (1).

On/Off (1) is lit.

The multi-function display (4) shows the start screen.

Unit is switched on.

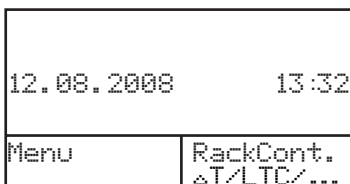

4.5.2 Switching off

Requirements Current program is completed.

→ Press On/Off (1).

Unit is switched off.

4.6 Working with the CombiDial

NOTICE

Open out the cover page to see the controls.

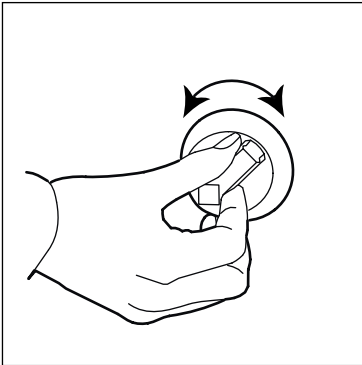

1. Turn the CombiDial (9) to select menu items or values.

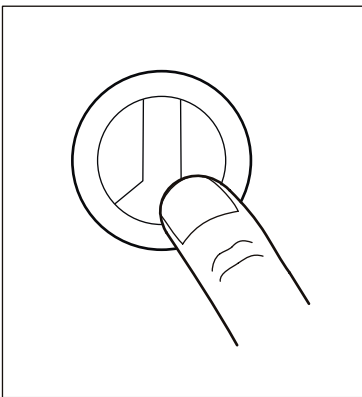

2. Press CombiDial (9) to confirm the selection.

4.7 Basic functions

4.7.1 Changing the language

Requirements Unit is switched on

1. Press the left select button (13) to open the menu.
2. Use CombiDial (9) to select the “Settings” menu.
3. Press the right select button (6).
4. Select the desired language with CombiDial (9).
5. Press the right select button (6) to save the settings.

4.7.2 Call up the setup menu and change parameters

Requirements Unit is switched on

1. Press the left select button (13) to open the menu.
2. Use CombiDial (9) to select the “Settings” menu.

3. Press CombiDial (9) to open the menu.
The multi-function display (4) shows “Password” and “000”.
4. Use CombiDial (9) to enter the password “111”.
5. Press Start/Stop (8).
The multi-function display (4) shows the first parameter “Time/Date” with the parameter number “000”.
6. Select the parameter using CombiDial (9).
7. Set the parameter to the desired value with CombiDial (9).
8. Press the right select button (6) to save the settings.
The display changes back to the parameter list.
9. Press the left select button (13) to exit the menu.

4.7.3 Displaying actual temperature values

The current cooking temperature can be displayed during operation.

→ Hold Cooking temperature (12) pressed for about 3 seconds.

The multi-function display (4) shows the current cooking temperature for 8 seconds. The target temperature is then shown again.

4.7.4 Set the cooking temperature

Requirements Unit is switched on

1. Press the cooking mode button.

The multi-function display (4) shows the preset cooking temperature and the cooking time.

2. Set the cooking temperature with CombiDial (9).



4.7.5 Setting the cooking time

NOTICE

Minimum: 1 minute.

Maximum: 23 hours, 59 minutes.

1. Press CombiDial (9) to switch to entering the cooking time.
2. Set the time with CombiDial (9).
3. For continuous operation: With a time display of "0:00", turn CombiDial (9) to the left and hold for 3 seconds.

The time display changes to "--".

4.7.6 AtmosControl climate control system (set chamber humidity)

The cooking chamber humidity currently set is shown in the Info monitor (18).

NOTICE

After selecting the cooking mode, the standard settings for this cooking mode are shown in the Info monitor (18).

→ Set the chamber humidity with set button (16) or set button (17)

4.7.7 Measuring the core temperature

⚠ DANGER

Risk of injury due to the sensor bursting.

The probe tip may burst if it becomes overheated.

→ Never heat sensors with a lighter or other source of heat.

NOTICE

Use core temperature measurement with all programs if possible.

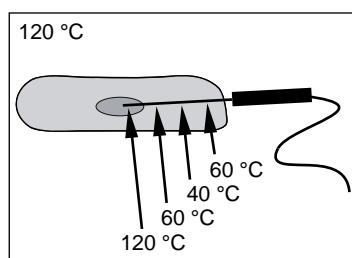

The sensor measures the core temperature at four points; the coldest point measured is used for controlling the cooking process. This means that the tip of the sensor may be positioned somewhat away from the core of the food to be cooked.

- Insert the sensor into the food to be cooked at the thickest point.
- For roasting cuts with bone (e.g. cutlets), insert the sensor close to the bone.
- With long roasts (e.g. sides of pork), insert the sensor crosswise in order to avoid a hole in the middle of the slices when cutting.
- With poultry, insert the sensor in the inner side of the thigh.

1. If possible, thaw frozen food before cooking.
2. Insert the sensor into the food to be cooked.
3. Place the food with the sensor in the middle of the cooking chamber.

4.7.8 Connecting the USB memory stick

Requirements A suitable USB memory stick is available.

NOTICE

Use an extension cable for USB memory sticks which cannot be connected to the interface due to their size.

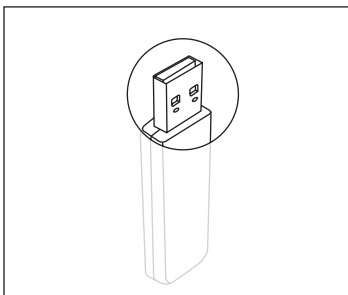

1. Open the black cap under the switch cover.
 2. Insert the USB memory stick with the opening to the rear.
- The USB memory stick is ready to use after about 5 seconds.
The USB memory stick is connected.

4.7.9 Saving the HACCP log

Requirements The USB memory stick is connected.

The device stores up to 200 HACCP logs, depending on the number of program steps.

HACCP logs can be saved via the USB interface with a USB memory stick.

1. Press the left button (13) to open the menu.
 2. Press CombiDial (9) to select the “HACCP” menu.
 3. Press CombiDial (9) (9) to select the HACCP log to be saved.
 4. Press the right Select button (6) briefly to save the selected HACCP log.
- or
- Press and hold down the right Select button (6) to save all HACCP logs from the one selected through to the latest HACCP log (daily or weekly overview).

The HACCP log is saved on the USB memory stick.

While it is saving, the multi-function display (4) flashes “Please wait” on the screen.

Once it has been saved, the multi-function display (4) flashes “Complete” on the screen.

NOTICE

If a file of the same name is already on the USB memory stick, the new HACCP logs will be attached.

4.7.10 Saving error messages

Requirements The USB memory stick is connected.

Error messages which occurred during operation can be saved on a USB memory stick.

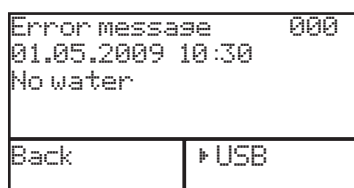

1. Press the left button (13) to open the menu.
 2. Press CombiDial (9) to select the “Diagnosis” menu.
- Multi-function display (4) shows the latest error message.

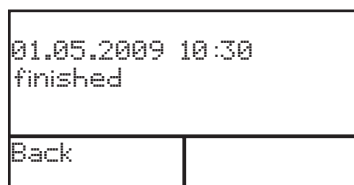

3. Press the right button (6) to save the error messages.
- Error messages are saved on the USB memory stick.

While it is saving, the Multi-function display (4) flashes “Please wait” on the screen.

Once it has been saved, the multi-function display (4) shows “Complete” on the screen.

NOTICE

If a file of the same name is already on the USB memory stick, it will be overwritten.

4.8 SmartMenu (automatic cooking)

4.8.1 Selecting the cooking program

1. Switch on the unit.
2. Press SmartMenu (2).

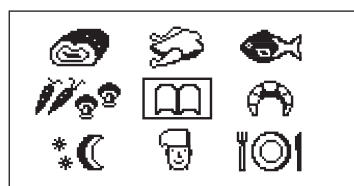

The multi-function display (4) shows the SmartMenu cooking categories.

- Meat (steak, roast pork)
 - Poultry (chicken, turkey)
 - Fish (perch fillet, trout)
 - Vegetables, side dishes (carrots, mushrooms, potatoes)
 - Bakery products (bread, croissants)
 - Overnight cooking (core temperature cooking, low temperature cooking)
 - MyChef Special (individual programs and programs that can not be assigned to other categories)
 - Perfection (plate dishes, banquets)
 - Cookbook (contains all cooking programs)
3. Using CombiDial (9), select the SmartMenu cooking category.

Cauliflower, fresh 01/	
02	
Beans, green	
Fried potatoes	
Prior Programs	Delete Program

The list is in alphabetical order; the first program flashes.

4. Select the cooking program with CombiDial (9).

The multi-function display (4) shows the name of the cooking program, the number of program steps and the respective values for temperature and cooking time.

Fried potatoes		01/
Combisteaming		02
170 °C	0:30	
More Functions	Home	

- 1 Name of the program
- 2 Total number of program steps
- 3 Current program step
- 4 Cooking time or core temperature for the program step
- 5 Cooking mode for the current program step
- 6 Target temperature for the current program step

4.8.2 Starting the cooking program

- Select the cooking program with one of the following buttons:
- Start/Stop (8)
 - Ready2Cook (10)
 - Cooking time (11) (hold pressed)

The multi-function display (4) will show the name of the program and the cooking mode for the first cooking step.

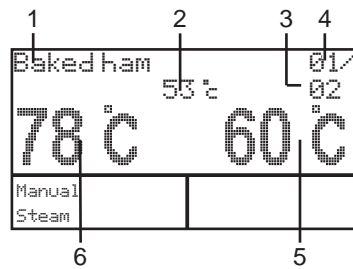

- 1 Name of the program
- 2 Actual core temperature
- 3 Total number of program steps
- 4 Current program step
- 5 Target core temperature
- 6 Target chamber temperature

4.8.3 Ending the cooking program

The program is ended automatically after the cooking time is over or when the core temperature is reached.

A signal sounds and the lighting in the cooking chamber flashes.

→ Press Start/Stop (8) or open the door of the chamber to turn off the signal.

or

→ Press Start/stop (8) to end the program prematurely.

4.8.4 Display last program

1. Press SmartMenu (2).
2. Press CombiDial (9).
3. Press the left select button (13) to display the last cooking program.

The programs that were last used are shown, up to a maximum of ten.

4.8.5 Changing the cooking program during operation

You can change the cooking time, cooking temperature or target core temperature for the individual cooking steps during operation by using the buttons Core temperature (7), Cooking time (11), Cooking temperature (12) and CombiDial (9).

NOTICE

Changes made during operation only apply to the running program and are not adopted as default values.

1. Press Core temperature (7), Cooking time (11) or Cooking temperature (12).
2. Change the values with CombiDial (9).

An asterisk (1) alongside the program name indicates that the saved program has been modified temporarily.

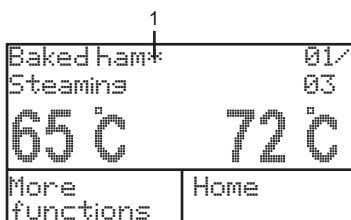

4.8.6 Save changed program

NOTICE

Always save programs that you have copied and changed under a new name.

1. Press SmartMenu (2) longer.
The program will be saved.
The multi-function display (4) shows the SmartMenu cooking categories.

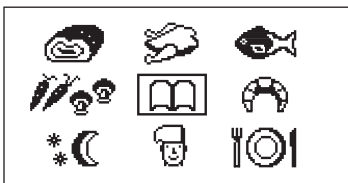

2. Use CombiDial (9) to select the SmartMenu cooking category.
The multi-function display (4) shows "Saved" for three seconds.
Then the display returns to the stand-by mode.

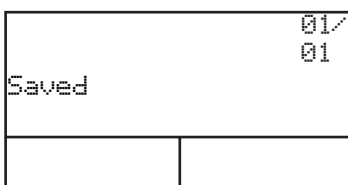

4.8.7 Create your own cooking programs

The unit can store up to 350 programs.

There are two ways of creating your own programs:

- Copy an existing cooking program, make individual adjustments and save it under a new name in the SmartMenu program memory.
- Create a new cooking program and save it in the SmartMenu program memory. It makes no difference whether you save a program first and then start it or start it first and then save it.

4.8.8 Entering a cooking program (example)

The process of creating and storing a two-step cooking program is described using the “Baked ham” program as an example.

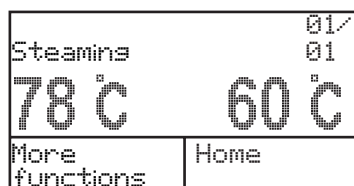

1. Press Steaming (15).
2. Set the cooking temperature.
3. Set the cooking time.
4. Set the target core temperature.

Cooking temperature: 78 °C (172.4 °F), core temperature: 60 °C (140 °F)

5. Press Convection (14).
6. Set the cooking temperature.
7. Set the cooking time.
8. Set the target core temperature.

Cooking temperature: 180 °C (356 °F), core temperature: 65 °C (149 °F)

9. Hold SmartMenu (2) pressed for 4 seconds.
10. Enter a name for the new program with CombiDial (9).
Press the left select button (13) to switch between upper and lower case letters or for special characters.
Press the right select button (6) to correct mistakes.

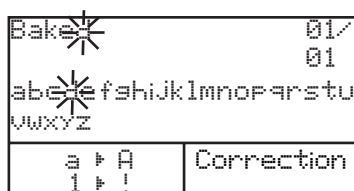

11. Press SmartMenu (2) longer.
The program will be saved.

The multi-function display (4) shows the SmartMenu cooking categories. The Info monitor (18) shows in text format the respective SmartMenu cooking category that is selected.

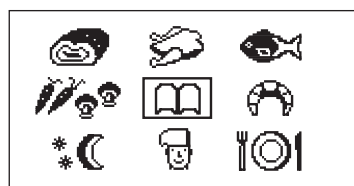

12. Use CombiDial (9) to select the SmartMenu cooking category.
The multi-function display (4) shows “Saved” for five seconds.

4.8.9 Copying a cooking program

Each program can be modified individually.

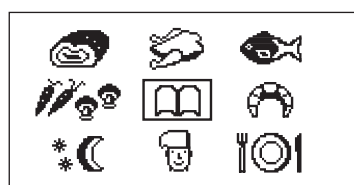

1. Press SmartMenu (2).
The multi-function display (4) shows the SmartMenu cooking categories.
2. Use CombiDial (9) to select the SmartMenu cooking category.



3. Select the cooking program with CombiDial (9).

The multi-function display (4) shows the name of the cooking program, the number of program steps and the respective values for temperature and cooking time.

4. Set the values for temperature and time with CombiDial (9).
5. Add further program steps if needed.

An asterisk appears next to the program name as soon as a change is made.

6. Press SmartMenu (2) longer.

The program will be copied.

The multi-function display (4) shows the original program name.

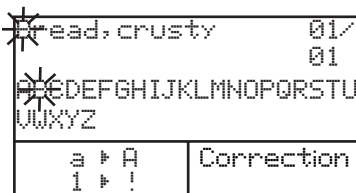

7. Enter a name for the new program with CombiDial (9).
Press the left select button (13) to switch between upper and lower case letters or for special characters.
Press the right select button (6) to correct mistakes.

4.8.10 Locking and releasing the SmartMenu program memory

In the “Settings menu”, you can mark the SmartMenu program memory as fully accessible or locked.

1. Press the left select button (13) to open the menu.
2. Use CombiDial (9) to select the “Settings” menu.
3. Use CombiDial (9) to enter the password “111”.
4. Use CombiDial (9) to select the “Lock program memory” menu.

Programs in the SmartMenu program memory can no longer be created, modified or deleted.

NOTICE

Proceed as described here to release the SmartMenu program memory.

4.8.11 Saving SmartMenu cooking programs

Requirements The USB memory stick is connected.

CAUTION

Loss of data due to improper use

→ Only use Henny Penny software to edit SmartMenu cooking programs

NOTICE

SmartMenu cooking programs can be saved on a USB memory stick. Only SmartMenu cooking programs which you have made can be saved. Saving preinstalled cooking programs is not possible.

1. Press the left button (13) to open the menu.
2. Press CombiDial (9) to select the “Cookbook > USB” menu.
3. Press the right button (6) to save SmartMenu cooking programs.

SmartMenu cooking programs are saved on the USB memory stick.

While it is saving, the multi-function display (4) flashes “Cookb. edition active” on the screen.

Once it has been saved, the multi-function display (4) flashes “Complete” on the screen.

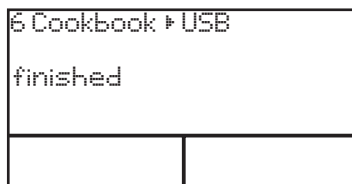
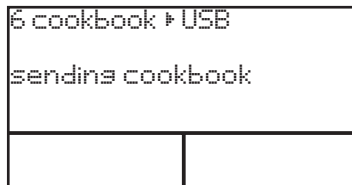

NOTICE

If a file of the same name is already on the USB memory stick, it will be overwritten.

4.8.12 Loading SmartMenu cooking programs

Requirements The USB memory stick is connected.

Appropriate files with SmartMenu cooking programs are already on the USB memory stick.

SmartMenu cooking programs which have been made on other Henny Penny-combination steamers of the “SmartCombi” or “SpaceSaver PLUS” versions or with Henny Penny software, can be loaded from a USB memory stick.

1. Press the left button (13) to open the menu.
2. Press CombiDial (9) to select the “USB > cookbook”.
3. Press the right button (6) to open SmartMenu cooking program files.

7 USB + cookbook	
receiving	1

7 USB + cookbook	
Cookbook loaded	50

4. Press CombiDial (9) to select SmartMenu cooking programs to load.

5. Press the right button (6) to SmartMenu cooking programs.

SmartMenu cooking programs are loaded from the USB memory stick.

While it is saving, the multi-function display (4) flashes “Loading” on the screen.

The total number of cooking programs loaded appears.

Once it has been saved, the multi-function display (4) shows “Cookbook loaded” on the screen and the total number of loaded cooking programs.

NOTICE

If a SmartMenu cooking program of the same name is already on the device, it will be overwritten.

4.9 Manual cooking

4.9.1 Starting the steaming process

Requirements Unit is switched on

1. Press Steaming (15).
2. Set the cooking temperature.
3. Set the cooking time.
4. Set the target core temperature if desired.
5. Load the unit.
6. Insert the core temperature sensor into the food to be cooked (see [Chapter “Measuring the core temperature”, Page 39](#)).
7. Press Start/Stop (8).

The multi-function display (4) shows:

- the set cooking temperature
- the set cooking time
- the target core temperature

4.9.2 Start Combisteaming

Requirements Unit is switched on.

1. Press Combisteaming (3).
2. Set the cooking temperature.
3. Set the cooking time.

4. Set the target core temperature if desired.
5. Set the chamber humidity.
6. Load the unit.
7. Insert the core temperature sensor into the food to be cooked (see [Chapter “Measuring the core temperature”, Page 39](#)).
8. Press Start/Stop (8).

The multi-function display (4) shows:

- the set cooking temperature
- the set cooking time
- the target core temperature

4.9.3 Starting the convection cooking mode

Requirements Unit is switched on

Unit has been preheated for at least 10–15 minutes with the “Ready2Cook” function.

1. Press Convection (14).
2. Set the cooking temperature.
3. Set the cooking time.
4. Set the target core temperature if desired.
5. Load the unit.
6. Insert the core temperature sensor into the food to be cooked (see [Chapter “Measuring the core temperature”, Page 39](#)).
7. Press Start/Stop (8).

The multi-function display (4) shows:

- the set cooking temperature
- the set cooking time
- the target core temperature

4.9.4 Starting perfection mode (climate and regeneration)

Requirements Unit is switched on

Unit has been preheated for at least 10–15 minutes with the “Ready2Cook” function.

1. Press Perfection (5).
2. Set the cooking temperature.
3. Set the cooking time.

4. Set the target core temperature if desired.
5. Set the chamber humidity.
6. Load the unit.
7. Press Start/Stop (8).

The multi-function display (4) shows:

- the set cooking temperature
- the set cooking time
- the target core temperature

4.9.5 Start Delta-T cooking

Requirements Unit is switched on

NOTICE

Since the core temperature of the food being cooked is needed, you must use the core temperature sensor with Delta-T cooking.

1. Press the right select button (6).

The multi-function display (4) shows “ΔT cooking” and “LT cooking”.

2. Use CombiDial (9) to select “ΔT cooking”.

NOTICE

Delta-T cooking is possible with the “Steaming”, “Combisteam” and “Convection” cooking modes.

3. Press cooking mode button.

The key's LEDs are lit.

The multi-function display (4) shows the cooking mode, Delta-T value and target core temperature.

4. Use CombiDial (9) to set the Delta-T value.
5. Set the target core temperature with CombiDial (9).
6. Press Start/Stop (8) to start the cooking program.

The multi-function display (4) shows the current chamber temperature and the target core temperature.

4.9.6 Starting low temperature cooking

Low temperature cooking without core temperature measurement

Set the chamber temperature manually to about 5 °C (41 °F) higher than the desired target core temperature.

Low temperature cooking with core temperature measurement

With this function, the selected cooking mode is automatically switched to “Keep warm” once the temperature of the food item has reached 80% of the target core temperature.

NOTICE

If the difference between the chamber temperature and the target core temperature is less than 5 °C (41 °F), it is possible that the target core temperature will not be reached.

1. Press the right select button (6) to call up the menu.
2. Use CombiDial (9) to select “LT cooking”.
3. Set the cooking temperature with CombiDial (9).
The multi-function display (4) shows the cooking time.
The cooking time “0:00” flashes.
4. Set the cooking time with CombiDial (9).
5. Press Start/Stop (8) to start the cooking program.

4.10 Advanced cooking functions

4.10.1 Programmable steaming

Requirements Unit is switched on
Chamber temperature is below 130 °C (266 °F)

NOTICE

If the chamber temperature is over 130 °C (266 °F), the function “Programmable steaming” is not carried out.

1. Press the right select button (6) to call up the menu.
2. Use CombiDial (9) to select the “Programmable steaming” menu.
3. Use CombiDial (9) to set the cooking chamber temperature (30 (86)–130 °C (266 °F)) and water quantity (0–5000 ml).
4. Press CombiDial (9) to enter further program steps.
5. Press Start/Stop (8) to start the cooking program.

While the program is running, the multi-function display (4) shows:

- The remaining time for all program steps
- the cooking mode
- the active program step
- the amount of water remaining (ml)

4.10.2 Manual steaming

NOTICE

The advanced function **Manual steaming** is not programmable and, therefore, cannot be included in the SmartMenu program memory.

→ Press the left select button (13).

The humidity in the chamber will be increased as long as the select button (13) is pressed.

4.10.3 Setting the rest period

Requirements Unit is switched on

With the advanced cooking function **Rest period**, you can specify a period during which the fan is inactive.

1. Press the right select button (6) to call up the menu.
2. Use CombiDial (9) to select the “Rest period” menu.
3. Set the rest period (in hours, minutes) with CombiDial (9).
4. Press CombiDial (9) to enter further program steps.
5. Press Start/Stop (8) to start the cooking program.

While the program “Rest period” is running, the multi-function display (4) shows:

- “Pause”
- the remaining time for all program steps
- the active program step
- the remaining time for the active program phase

4.10.4 Setting the preset start time

⚠ CAUTION

Dangers to health due to spoiled food

When using the preset start time feature, temperatures may occur in the cooking chamber that encourage the growth of harmful germs.

→ Observe the provisions governing foodstuffs.

1. Select the cooking program.
2. Hold Cooking time (11) pressed.

The multi-function display (4) shows “Start in: 00:01”.

3. Set the delay period with CombiDial (9).

If a program without core temperature measurement follows, the finish time is shown. “Ready at: ”.

If a program with core temperature measurement follows, the target core temperature is shown.

4. Press CombiDial (9) to confirm the preset start time.

The multi-function display (4) shows the remaining delay time and the cooking chamber temperature.

Once the delay period has elapsed, the program that was set will be started automatically.

NOTICE

The lighting in the cooking chamber is switched off during the delay period.

5. Press the left select button (13) to end the preset start time.

4.10.5 Starting Ready2Cook (prepare for cooking)

The advanced function **Ready2Cook** heats if the cooking chamber is too cold, cools if it is too hot and prepares the cooking climate for cooking.

→ Press Ready2Cook (10) briefly: The chamber will be heated to a temperature 15 % higher than that of the first program step (default value).

or

→ Press Ready2Cook (10) longer: The cooking chamber will be preheated to 275 °C (527 °F).

4.10.6 Working with RackControl

Requirements Unit is switched on.

1. Press the right select button (6).

The multi-function display (4) flashes "RackControl".

2. Press the right select button (6) or CombiDial (9) to confirm the selection.

The multi-function display (4) shows "Select cooking mode".

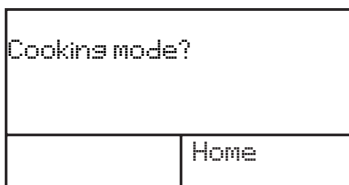

3. Press the cooking mode button.

The LEDs for the cooking mode button are lit.

The multi-function display (4) flashes the preset cooking temperature for this cooking mode.

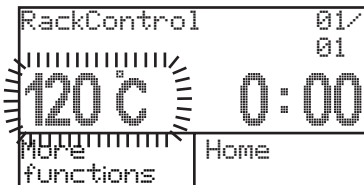

4. Set the cooking temperature with CombiDial (9).

5. Press Cooking time (11).

6. Set the cooking time with CombiDial (9).

The set cooking time will then be used as the specified value for the individual areas (racks).

NOTICE

The cooking time can be adjusted for each individual area, if necessary.

7. Press Start/Stop (8).

The key's LED flashes.

The unit operates continuously.

The multi-function display (4) shows the five areas with the specified values.

An arrow indicates the selected area.

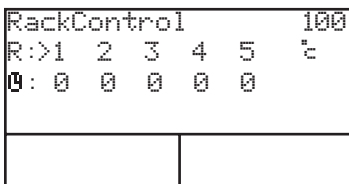

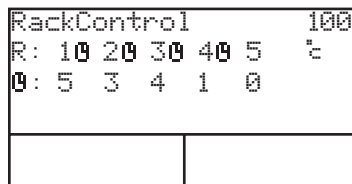
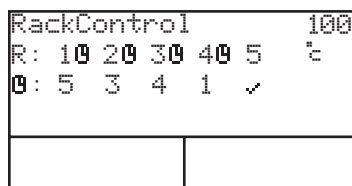
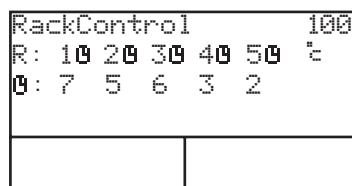
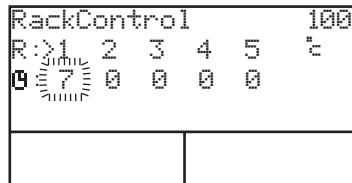
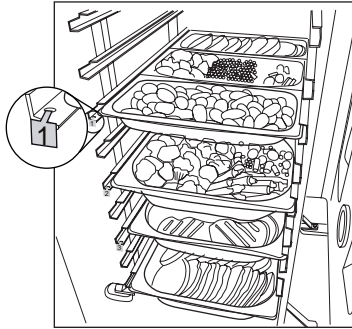

8. Place containers with food in the cooking chamber, mark with heat-resistant tags if necessary R1, R2 etc.
9. Select the area for which you want to change the cooking time with CombiDial (9).

10. Set the cooking time with CombiDial (9).

11. Press CombiDial (9) to start the time signal for this area.

The multi-function display (4) shows a clock icon next to the selected area.

12. Set the cooking time for additional areas.

The multi-function display (4) shows the remaining time for all five areas.

13. A signal sounds when the cooking time is over.

The clock icon disappears from the multi-function display (4) for this area.

A tick is shown instead of the remaining time.

14. Remove containers.

New plates can be placed in the area that is now free.

Start the cooking time for the newly loaded area as previously described.

15. Press Start/Stop (8) to end RackControl.

4.10.7 Reduced heat output

The advanced cooking function **Reduced heat output** cannot be programmed; it must be selected manually with each new start.

→ Press Start/Stop (8) for longer when starting the program.

The multi-function display (4) shows "E/2".

With tabletop units: A heating circuit is deactivated.

With floor standing units: The lower chamber is turned off.

4.11 Add functions

4.11.1 Activate/deactivate add functions

1. Press the left select button (13) while entering data.

NOTICE

There are always only those add functions available that can be used in the respective cooking mode.

2. Turn CombiDial (9) and select the additional function.
The selected function flashes.
3. Press CombiDial (9) and activate or deactivate the additional function.
4. Make adjustments with CombiDial (9) as necessary.
5. Press the left select button (13) to return to the settings menu.

4.11.2 Modify add function

Most add functions can also be activated or deactivated during operation.

1. Press one of the following buttons briefly:
 - Core temperature (7)
 - Cooking time (11)
 - Cooking temperature (12)
2. Select the cooking step for which you want to activate or deactivate an additional function with CombiDial (9).
3. Press the left select button (13).
4. Select the additional function with CombiDial (9).

4.11.3 Reducing the fan speed

1. Select the additional function "Reduced fan speed".
2. Set the desired fan speed with CombiDial (9).

4.11.4 Activating the end-of-step signal

With multi-step programs, the end-of-step signal can be activated for each cooking step.

NOTICE

The end-of-step signal is activated as default for the last cooking step of a program.

1. Press the left select button (13) when entering a cooking program.
2. Select the end-of-step signal with CombiDial (9).
3. Press the left select button (13) to return to the settings menu.

4.12 Changing standard settings

Requirements Unit is switched on

1. Press the left select button (13) to open the menu.
2. Use CombiDial (9) to select the “Settings” menu.
3. Use CombiDial (9) to enter the password “111”.
4. Press Start/Stop (8).
5. Select the parameter with CombiDial (9).

The multi-function display (4) shows the set value.

The parameter name flashes.

6. Press CombiDial (9), to change the value.

The parameter value flashes.

7. Change the value with CombiDial (9).
8. Press the right select button (6) or CombiDial (9) to adopt the value.

The parameter name flashes.

9. Change other parameters as necessary.
10. Press the right select button (6) to save the changes.

or

→ Press the left select button (13) to discard the changes.

4.12.1 Set service interval water volume

In the “Settings” menu, you can specify the service interval by means of the volume of used water.

1. Press the left select button (13) to open the menu.
2. Use CombiDial (9) to select the “Settings” menu.

3. Use CombiDial (9) to enter the password “111”.
4. Use CombiDial (9) to select the “Service water volume” menu.
5. Set the water volume (in 100 litre increments) with CombiDial (9).

4.13 Standard settings

The unit is already pre-configured when delivered.

The values listed in the following table can be adjusted individually (see [Chapter “Changing standard settings”, Page 57](#)).

No.	Parameters	Pre-set value	Possible settings	Explanation
000	Time/date	The operator's local time	Time/date	Changeover summer time/winter time is automatic. Date format: Parameter 144
006	Temperature reading	in °C	°C/°F	Temperature display in °F is irrespective of the system language.
023	Lighting flashes	On	On/off	On: At the end of the cooking time the lighting flashes in addition to the acoustic signal sounding. It flashes as long as the signal sounds.
082	Preheat factor %	15	0–30 %	Increase the preheat factor for full loads of large masses (roasts, loaves of bread) to prevent the temperature from falling too much.
076	Service water volume	0	0–90000 l in 100 l increments	Applies for external water preparation systems and only for the soft water connection. See Chapter “Set service interval water volume”, Page 57 for further information.
144	Date format	DD.MM.YYYY	<ul style="list-style-type: none"> • DD.MM.YYYY • YYYY/MM/DD • MM/DD/YYYY 	DD = day MM = month JJJJ = year
097	SmartMenu program memory	Free	<ul style="list-style-type: none"> • Free • Blocked • Fully blocked 	<ul style="list-style-type: none"> • Free: you can change, delete or save programs • Blocked: you may not change, delete or save programs. But you may make changes during the cooking process. • Fully blocked: No changes are possible in the SmartMenu program memory or during the cooking process.
032	Time delay fan	Off	On/off	Set “fan cycle operation”. The temperature in the cooking chamber can be kept to 14 °C (57.2 °F) for 6 h by placing an ice block in the bottom drawer.

No.	Parameters	Pre-set value	Possible settings	Explanation
024	Cooling waste steam	Normal	Minimum, Normal, Maximum	<ul style="list-style-type: none"> • “Minimum”: Minimum water consumption but higher condensation temperature and a greater volume of waste steam. • “Maximum”: Maximum water consumption but low condensation temperature and a low volume of waste steam. <p>At this setting, the drain temperature is < 60 °C (140 °F).</p>
083	Time ext. hood (sec.)	60	0–600 seconds	An external extraction hood can be switched on at the end of the program.
084	Beep time (sec.)	20	0–180 seconds	0 = beep off
015	Altitude	0–500 m.	<ul style="list-style-type: none"> • 0–500 m (1,640 ft.) • 500 m (1,640 ft.)–1000 m (3,281 ft.) • 1000 m (3,281 ft.)–1500 m (4,921 ft.) • > 1500 m (4,921 ft.) 	Altitude above sea level. Set to 0–500 m (1,640 ft.) if the altitude is not known.
096	Password	111	000–500	Individual passwords can be configured in this area.
225	Scroll direction	Normal	Normal/inverse	Rotation direction of CombiDial (9) in menus and in the SmartMenu program memory.
235	Temp. Steam	100 °C	30–130 °C	The default cooking temperature for this cooking mode can be set within the shown limits.
236	Temp. Combi	130 °C	30–250 °C	The default cooking temperature for this cooking mode can be set within the shown limits.
237	Temp. Convec.	180 °C	30–300 °C	The default cooking temperature for this cooking mode can be set within the shown limits.
238	Temp. Regeneration	120 °C	30–180 °C	The default cooking temperature for this cooking mode can be set within the shown limits.
239	Temp. LT cooking	60 °C	60–100 °C	The default cooking temperature for this cooking mode can be set within the shown limits.
240	Temp. DT cooking	20 °C	1–100 °C	The default cooking temperature for this cooking mode can be set within the shown limits.
241	Temp. T-Core	60 °C	30–99 °C	The default cooking temperature for this cooking mode can be set within the shown limits.

Operation

No.	Parameters	Pre-set value	Possible settings	Explanation
242	History	0	0–10	With “History” you can display the most recently used programs (max.10) and start them again.
397	Standard category	Cookbook	<ul style="list-style-type: none"> • Meat • Poultry • Fish, vegetables • Side dishes, bakery products • Overnight cooking • MyChef special • Perfection • Cookbook 	

No.	Parameters	Pre-set value	Possible settings	Explanation
403	SmartMenu program memory number	0	<ul style="list-style-type: none"> • 0 = Only self-created cooking programs • 1 = German • 2 = English GB • 3 = Italian • 4 = French • 5 = Dutch • 6 = Spanish • 7 = Polish • 8 = Danish • 9 = Russian • 10 = Czech • 11 = Lithuanian • 12 = Latvian • 13 = Chinese GB China • 14 = Chinese Big5 Taiwan • 15 = Korean • 16 = Hebrew • 17 = Slovenian • 18 = Croatian • 19 = Hungarian • 20 = English SC • 21 = Swedish • 22 = Turkish • 23 = Slovakian • 24 = Serbian • 25 = Greek • 26 = Portuguese • 30 = German (A) • 31 = German (CH) • 32 = English (Asia) • 100 = Henny Penny English 	<p>You can load SmartMenu program memories for a specific country.</p> <p>Programs that were deleted can also be recreated in this way.</p> <p>Select SmartMenu program memory and then save. After switching the SmartMenu program memory, press "Save".</p> <p>The display shows "Analysis". Programs that were created on the unit are retained when switching over.</p>

Table 7: Standard settings

5 Cleaning

5.1 Automatic cleaning “WaveClean”

5.1.1 Preparing the cooking chamber

Requirements GN containers, baking sheets and racks have been removed from the cooking chamber

CAUTION

Damage caused by unsuitable cleaning agents

→ Only use Henny Penny products for cleaning the cooking chamber.

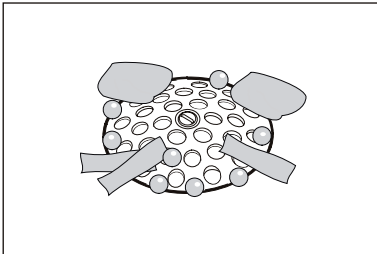

1. Leftover food has been removed from the cooking chamber. The drain sieve must be clear.
2. With tabletop units: only leave the slide-in frame in the cooking chamber.
With floor standing units: push empty trolleys into the cooking chamber.
3. Close cooking chamber door.

5.1.2 Selecting the WaveClean level

Requirements Unit is switched on

1. Press the left select button (13).
The multi-function display (4) shows the cleaning menu.
2. Use CombiDial (9) to select the “WaveClean” menu.
3. Select the cleaning level with CombiDial (9).
 - WaveClean, short: duration approx. 1 hour
 - WaveClean, normal: duration approx. 2 hours
 - WaveClean, extra: duration approx. 3 hours (for heavy soiling)

NOTICE

All cleaning levels require the same amount of water although the time required for cleaning is different.

4. Press CombiDial (9) to confirm the selection.
The chamber will be heated or cooled automatically until it reaches the WaveClean temperature of 50 °C (122 °F).

5.1.3 Using the WaveClean cartridge

Only use sealed cartridges.

If the wax seal is damaged, this may lead to the cleaning agent entering the cleaning cycle too early or not dissolving fully; in this case thorough cleaning is not guaranteed.

Do not place the cartridge on the floor of the chamber.

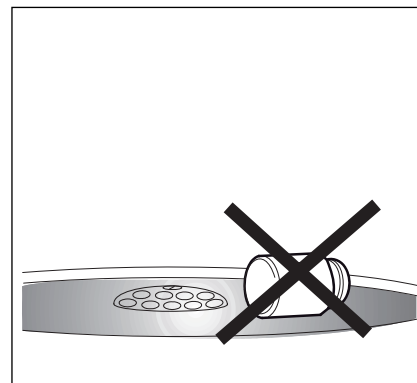
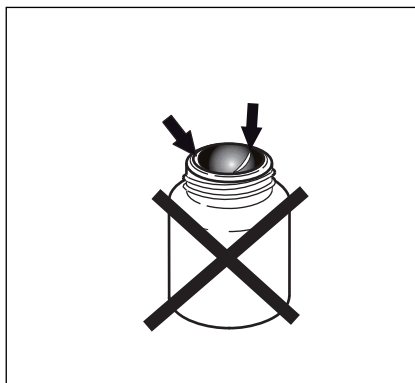

When the chamber has reached the cleaning temperature, the multi-function display (4) shows “Insert cartridge”.

1. Open the chamber door.
2. Unscrew the cartridge lid.

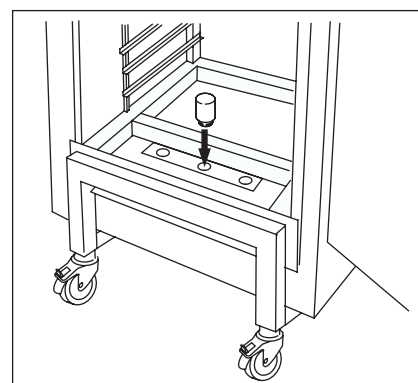
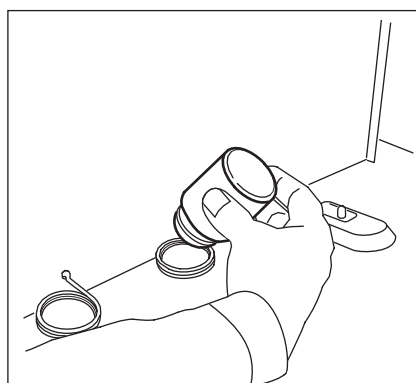

3. With tabletop units: place cartridge in the holder in front of the ventilation plate.
With floor standing units: place cartridge in the holder of the rack trolley.

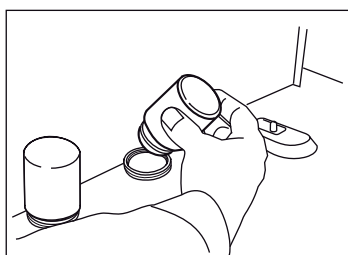

NOTICE

Use additional cartridges if necessary:

- If heavily soiled: use 2 two-in-one cartridges. Select “WaveClean extra”.
- If scaled: use a two-in-one cartridge + clear rinse cartridge.

5.1.4 Start WaveClean

Requirements Hard water and soft water taps are open

→ Close the chamber door and confirm with the right select button (6).

The cleaning program starts. The multi-function display (4) shows the remaining cleaning time.

5.1.5 Ending WaveClean

The unit switches itself off automatically when the cleaning process is finished. The multi-function display (4) shows “Remove cartridge” when the unit is restarted.

1. Open the cooking chamber door.
2. Remove the empty cartridge.
3. Rinse thoroughly by hand to remove any cleaner or rinsing agent residues.

NOTICE

See [Chapter “WaveClean faults”, Page 65](#) for possible causes of cleaner residues in the cooking chamber.

4. Close the cooking chamber door.
5. Press the right select button (6) and confirm that the cartridge has been removed.
6. Open the chamber door and leave it slightly ajar until the next use.

This will increase the life of the door seal.

No moisture will build up in the cooking chamber.

5.1.6 Cancelling WaveClean

The “WaveClean” automatic cleaning function can also be ended manually.

Power failure during cleaning also leads to the process being terminated.

→ Press the left select button (13) to abort the cleaning program.

NOTICE

For safety reasons, a rinsing process (duration 12 minutes) runs automatically when WaveClean is cancelled.

5.1.7 “WaveClean” faults

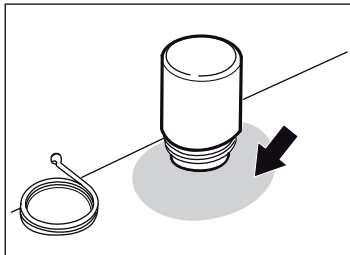

Discolouring may occur to the floor of the cooking chamber underneath the cartridge. This discolouring is harmless and does not have any effect on the operation of the unit.

Fault	Possible cause	Remedy
<ul style="list-style-type: none"> • Cartridges are not fully emptied • Residues of cleaner/rinsing agent remain in the cartridge • Rinsing agent is released at the same time as the cleaner 	Unit is leaning	Adjust the unit horizontally
	Power failure/unit malfunction	Contact customer service
	Holder is bent: cartridge too close to the floor	Adjust holder position
	Heater not working	Contact customer service
• Cooking chamber remains dry	Circulating pump defective	Contact customer service
• Cooking chamber is not clean	Cooking chamber too heavily soiled	<ul style="list-style-type: none"> • Empty outlet filter before cleaning. • Remove heavy soiling and large particles manually before cleaning. • Shorten the cleaning interval.
	Washing water circulation interrupted	

Table 8: Causes of faults and troubleshooting

Information regarding operation with hard water

NOTICE

The unit can be used without softening the water up to a hardness of 5 °dH. However, water having a total hardness exceeding 0 °dH contains lime scale, which may form deposits in the cooking chamber.

The amount of lime scale deposited in the cooking chamber is normally so low that it has no detrimental effect on the operation of the unit. However, there may be white deposits in the cooking chamber.

The two-in-one cartridges contain a clear rinsing agent with descaling properties, which usually prevents these deposits from building up if the “WaveClean” automatic cleaning function is used regularly.

- Clean daily with the “WaveClean extra” cleaning level, even if the degree of soiling is low.
- Use a clear rinse cartridge in addition to the cleaning cartridge.
- Descale manually.

5.2 System-supported manual cleaning

5.2.1 Preparing the cooking chamber

Requirements GN containers, baking sheets and racks have been removed from the cooking chamber

CAUTION

Damage caused by unsuitable cleaning agents

→ Only use Henny Penny products for cleaning the cooking chamber.

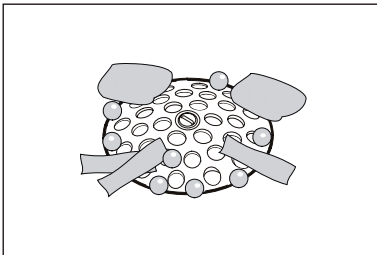

1. Leftover food has been removed from the cooking chamber. The drain sieve must be clear.
2. With tabletop units: only leave the slide-in frame in the cooking chamber.
With floor standing units: push empty trolleys into the cooking chamber.
3. Close cooking chamber door.

5.2.2 Start cleaning program

Requirements Unit is switched on

1. Press the left select button (13) to open the menu.
2. Use CombiDial (9) to select the menu “Man. cleaning”.
3. Press the right select button (6) to start the cleaning program.

The chamber will be cooled or heated automatically until it reaches the soaking temperature of 50 °C (122 °F).

The multi-function display (4) shows the current chamber temperature.

When the soaking temperature is reached, the multi-function display (4) shows the remaining soaking time.

5.2.3 Spraying cleaning solution

⚠ CAUTION

Risk of burns due to caustic liquids

- Wear protective clothing.
- Also wear respiratory protection because of the formation of aerosols or mists.

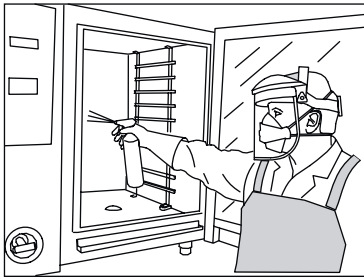

1. After soaking, the multi-function display (4) shows “Apply cleaning solution”.
2. Open the cooking chamber door.
3. Spray cooking chamber, heating register and fan wheel (by opening the ventilator plate) with cleaner.

5.2.4 Let the cleaner work

CAUTION

Damage caused by exceeding the recommended reaction time

The surface of the cooking chamber may be damaged due to the corrosive effects of the cleaner used.

- Do not allow the cleaner to react for longer than the period specified by the program.

- Close chamber door.

The reaction time starts after the chamber door is closed.

The unit is inactive during the reaction time. The multi-function display (4) shows the remaining reaction time.

5.2.5 Cleaning

The cleaning process starts at the end of the reaction time.

In this process, the chamber is heated to 80 °C (176 °F).

The multi-function display (4) shows the chamber temperature and the remaining cleaning time.

After the cleaning, the multi-function display (4) shows “Rinse cooking chamber”.

5.2.6 Rinsing out

1. Open the chamber door.
2. Remove ventilation plate (see [Chapter “Removing the ventilation plate”, Page 72](#)).
3. Thoroughly rinse the cooking chamber for about 3 minutes using the hand shower.
4. Replace ventilation plate.

5.2.7 Cleaning the door seal

1. Clean the door seal (see [Chapter “Cleaning the door seal”, Page 69](#)).
2. Close chamber door.

5.2.8 Drying

1. Drying starts automatically after closing the chamber door. The chamber will be heated to 130 °C (266 °F) for five minutes.
2. The multi-function display (4) shows the current chamber temperature and the drying time.
3. Open the chamber door and leave it slightly ajar until the next use. This will increase the life of the door seal. No moisture will build up in the chamber.

5.3 General cleaning

5.3.1 Cleaning the outside of the housing

CAUTION

Damage caused by water penetrating the electronic controls

The electronic controls are not splash-proof.

- Only use the hand shower for rinsing the cooking chamber.
- Do not spray the outside of the housing with the hand shower.

CAUTION

Damage to surfaces caused by incorrect cleaning

- Do not use abrasive cleaners or cloths.
- Do not use aggressive cleaners (e.g. oven cleaner).

→ Wipe the outside of the housing with tepid soapy water and a cloth.

5.3.2 Cleaning the cooking chamber

The unit is delivered with two cleaning programs as standard:

- “WaveClean” automatic cleaning system: automatic cleaning and rinsing of the cooking chamber
- menu guided manual cleaning

We recommend the use of the automatic cleaning system “WaveClean”.

You save the lengthy, and hence expensive manual cleaning. You don't come into contact with the cleaner, thanks to the use of the patented two-in-one cartridge.

5.3.3 Cleaning the door seal

Animal fats together with high temperatures can destroy the door seal in a short time if it is not cared for properly. For this reason, it is important to clean the door seal regularly to ensure a long service life.

NOTICE

When cleaning with “WaveClean” or system-supported manual cleaning, the outside of the door seal is not cleaned. The door seal must be cleaned separately after each cleaning.

Do not use aggressive cleaners!

1. Clean fats from the door seal after operation using a mild soap solution.
2. Also clean the door seal in breaks during operation if the unit is mainly used for roasting.

5.3.4 Cleaning the cooking chamber door

⚠ CAUTION

Risk of burns due to hot surfaces

→ Allow surfaces to cool before cleaning.

CAUTION

Damage to surfaces caused by incorrect cleaning

- Do not use abrasive cleaners or cloths.
- Do not use oven cleaner.

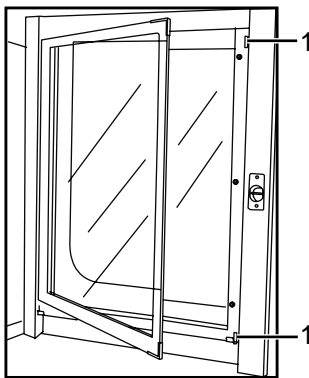

The inner glass plate of the cooking chamber door can be swung out.

1. Open the cooking chamber door to 90 degrees.
2. Remove the retaining spring (1) and swing out the inner glass plate to 90 degrees.
Do not lift the glass plate when swinging out.
Do not swing the glass plate out to its full extent.
Hold the inner glass plate during cleaning.
3. Remove scale residues from the glass plate with vinegar or citric acid.
4. Swing the inner plate back in after cleaning and allow the retaining spring (1) to click in place.

5.3.5 Cleaning the steam outlet port

Deposits can block the steam outlet port and the pipes connected to it.

NOTICE

Use liquid cleaner with a maximum of 10 % soda or caustic potash solution.

It is not necessary to rinse with water.

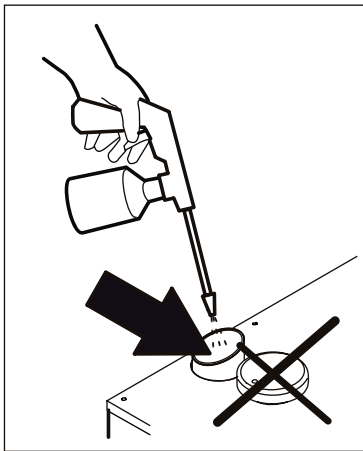

1. Inspect the steam outlet port and the pipes connected to it for deposits.
2. Spray liquid cleaner in the steam outlet port.
3. With units with a condensate hood (optional), remove the connecting pipe between the condensate hood and the steam outlet port twice a year.
4. Spray liquid cleaner into the steam outlet port and in the opening of the condensate hood.
5. Then replace the connecting pipe.

5.3.6 Descaling

Requirements

Cooking chamber temperature less than 40 °C (104 °F)

Cooking chamber is clean

To avoid a build-up of scale in the cooking chamber, only softened water should be used for operation.

If hard water is used, the cooking chamber must be descaled regularly to avoid damage to the unit.

Use Henny Penny special descaler together with a hand-held sprayer for manual decalcification.

1. Dilute the special descaler with water at the ratio of 1:2.
2. Open the ventilation plate so that the parts behind it are moistened.
3. Spray the diluted special descaler into the cooking chamber.
4. Allow the solution 30 minutes of contact time, then rinse the chamber thoroughly.

5. Examine the chamber for scale residues. Repeat decalcification if necessary.
6. Open the chamber door and leave it slightly ajar until the next use. This will increase the life of the door seal.
No moisture will build up in the cooking chamber.

5.4 Removing the ventilation plate

5.4.1 Removing the ventilation plate (table top models)

The ventilation plate can be removed for cleaning.

CAUTION

Risk of crushing fingers due to rotating fan

- Disconnect the unit from the power supply before you remove the ventilation plate.
- Do not operate the unit without the ventilation plate.

1. Remove the suspension frame on the left-hand side.
2. Open the front catch.
3. Fold the ventilation plate towards the rear wall.
4. Open the rear catch.
5. Slightly raise the ventilation plate and remove it.
6. Clean the cooking chamber behind the ventilation plate.
7. Push the ventilation plate onto the upper bolts.
8. Close the rear catch.
9. Fold the ventilation plate towards the side wall.
10. Close the front catch.
11. Check the catches.
12. Replace the suspension frame on the left-hand side.

5.4.2 Removing the ventilation plate (floor standing units)

Requirements Necessary tools: box spanner

The ventilation plate can be removed for cleaning.

⚠ CAUTION**Risk of crushing fingers due to rotating fan**

- Disconnect the unit from the power supply before you remove the ventilation plate.
- Do not operate the unit without the ventilation plate.

1. Remove the screws in the middle of the ventilation plate.
2. Open the front catch.
3. Fold the ventilation plate towards the rear wall.
4. Open the rear catch.
5. Slightly raise the ventilation plate and remove it.
6. Clean the cooking chamber behind the ventilation plate.
7. Push the ventilation plate onto the upper bolts.
8. Close the rear catch.
9. Fold the ventilation plate towards the side wall.
10. Close the front catch.
11. Check the catches.
12. Replace the screws in the middle of the ventilation plate.

6 Faults

6.1 Correcting faults

This section describes the steps to be taken in the event that faults with the unit occur during operation.

1. Reset control electronics ([Chapter “Resetting the control electronics”, Page 74](#)).
2. Observe the information in the table “Causes of faults and troubleshooting” ([Chapter “Cause of errors and troubleshooting”, Page 75](#)).
3. Contact customer service.

6.2 Resetting the control electronics

Requirements Unit is switched on

Errors in the program sequence (e.g. deviations from the set values) can be corrected by resetting (initialising) the control electronics.

This resets the electronics to the start mode.

NOTICE

Stored programs are not deleted when doing this!

1. Hold On/Off (1) pressed for about 8 seconds, until the control electronics switch off.
2. After about 10 seconds, the control electronics switch on again automatically.
3. If the unit is switched off and On/Off (1) is pressed for longer than 20 seconds, the control electronics change to **Demo mode**.

The multi-function display (4) shows “Demo mode”.

12.08.2008 13:32	
Demo mode	
Menu	RackCont. ΔT/LTC/...

4. To leave demo mode, switch off the unit and press On/Off (1) until the unit switches on again.

The control electronics switch back to the normal operating mode.

Unit is in start mode (standby).

12.08.2008 13:32	
Menu	
Menu	RackCont. ΔT/LTC/...

6.3 Cause of errors and troubleshooting

Error	Possible causes	Remedy
No water	Tap closed	<ul style="list-style-type: none"> Open tap
	Unit is defective	<ul style="list-style-type: none"> Contact customer service
Leakage of water underneath the unit	Fault in the waste water system	<ul style="list-style-type: none"> Do not use unit Contact customer service
No gas	Gas tap closed	<ul style="list-style-type: none"> Open gas tap
	Gas pressure too low	<ul style="list-style-type: none"> Check gas pressure
Cooking chamber overheated	Unit is defective	<ul style="list-style-type: none"> Do not use unit Contact customer service
STL triggered	Unit is defective	<ul style="list-style-type: none"> Contact customer service
Motor STL triggered	Motor overheated, cooling faulty	<ul style="list-style-type: none"> Allow unit to cool down Check cooling air intake Contact customer service
Electronics too warm	Heat source near to the cooling air intake Cooling air intake restricted or blocked Ambient temperature too high	<ul style="list-style-type: none"> Check cooling air intake Set a lower cooking temperature Contact customer service
Electronics too hot	Cooling faulty, ambient temperature too high	<ul style="list-style-type: none"> Do not use unit Check cooling air intake Contact customer service
Core temperature sensor faulty	Sensor broken	<ul style="list-style-type: none"> Use cooking program without core temperature measurement Contact customer service
Chamber sensor faulty	Sensor broken	<ul style="list-style-type: none"> Use cooking program without core temperature measurement Core temperature sensor as substitute for chamber sensor: <ul style="list-style-type: none"> Leave core temperature sensor in the chamber Do not insert the core temperature sensor into the food Contact customer service
No fan	<ul style="list-style-type: none"> Fan not working Missing phase Unit is defective 	<ul style="list-style-type: none"> Check electrical connection Observe safety information (see Chapter "Safety information", Page 10) Contact customer service
Danger of frost	Temperature below 0 °C (32 °F)	<ul style="list-style-type: none"> Observe the ambient air requirements for operation
Battery is flat	Back-up battery is flat (service life: approx. 8 years)	<ul style="list-style-type: none"> Stored data will be lost in the event of a power failure Contact customer service
Perform configuration	Necessary configuration not performed	<ul style="list-style-type: none"> Perform configuration Contact customer service

Faults

Error	Possible causes	Remedy
Expelled steam sensor broken	Waste water temperature measurement faulty, cooling water is permanently turned on	<ul style="list-style-type: none"> Unit can be used (emergency operation) Contact customer service
Humidity sensor faulty	Humidity sensor faulty, humidity emergency program is active	<ul style="list-style-type: none"> Unit can be used (emergency operation) Contact customer service
HW faulty: UREF0 T-measurement too high	Core temperature sensor or keypad defective	<ul style="list-style-type: none"> Contact customer service
General gas fault	Incorrect gas quality Unit is defective	<ul style="list-style-type: none"> Contact customer service
No gas fan	Unit is defective	<ul style="list-style-type: none"> Contact customer service
Line too long	File on USB memory stick is damaged	<ul style="list-style-type: none"> Repeat procedure for loading/saving
Missing s		
USB memory is full	Insufficient memory on USB memory stick	<ul style="list-style-type: none"> Use another USB memory stick
USB not available	USB memory stick is not inserted	<ul style="list-style-type: none"> Insert USB memory stick completely
	Faulty USB memory stick	<ul style="list-style-type: none"> Use another USB memory stick

Table 9: Cause of errors and troubleshooting

7 Limited Warranty

LIMITED WARRANTY FOR HENNY PENNY EQUIPMENT

Subject to the following conditions, Henny Penny Corporation makes the following limited warranties to the original purchaser only for Henny Penny appliances and replacement parts:

NEW EQUIPMENT: Any part of a new appliance, except baskets, lamps, and fuses, which proves to be defective in material or workmanship within two (2) years from date of original installation, will be repaired or replaced without charge F.O.B. factory, Eaton, Ohio, or F.O.B. authorized distributor. Baskets will be repaired or replaced for ninety (90) days from date of original installation. Lamps and fuses are not covered under this Limited Warranty. To validate this warranty, the registration card for the appliance must be mailed to Henny Penny within ten (10) days after installation.

FILTER SYSTEM: Failure of any parts within a fryer filter system caused by the use of the non-OEM filters or other unapproved filters is not covered under this Limited Warranty.

REPLACEMENT PARTS: Any appliance replacement part, except lamps and fuses, which proves to be defective in material or workmanship within ninety (90) days from date of original installation will be repaired or replaced without charge F.O.B. factory, Eaton, Ohio, or F.O.B. authorized distributor.

The warranty for new equipment covers the repair or replacement of the defective part and includes labor charges and maximum mileage charges of 200 miles round trip for a period of one (1) year from the date of original installation.

The warranty for replacement parts covers only the repair or replacement of the defective part and does not include any labor charges for the removal and installation of any parts, travel, or other expenses incidental to the repair or replacement of a part.

EXTENDED FRYPOT WARRANTY: Henny Penny will replace any frypot that fails due to manufacturing or workmanship issues for a period of up to seven (7) years from date of manufacture. This warranty shall not cover any frypot that fails due to any misuse or abuse, such as heating of the frypot without shortening.

0 TO 3 YEARS: During this time, any frypot that fails due to manufacturing or workmanship issues will be replaced at no charge for parts, labor, or freight. Henny Penny will either install a new frypot at no cost or provide a new or reconditioned replacement fryer at no cost.

3 TO 7 YEARS: During this time, any frypot that fails due to manufacturing or workmanship issues will be replaced at no charge for the frypot only. Any freight charges and labor costs to install the new frypot as well as the cost of any other parts replaced, such as insulation, thermal sensors, high limits, fittings, and hardware, will be the responsibility of the owner.

Any claim must be presented to either Henny Penny or the distributor from whom the appliance was purchased. No allowance will be granted for repairs made by anyone else without Henny Penny's written consent. If damage occurs during shipping, notify the sender at once so that a claim may be filed.

THE ABOVE LIMITED WARRANTY SETS FORTH THE SOLE REMEDY AGAINST HENNY PENNY FOR ANY BREACH OF WARRANTY OR OTHER TERM. BUYER AGREES THAT NO OTHER REMEDY (INCLUDING CLAIMS FOR ANY INCIDENTAL OR CONSEQUENTIAL DAMAGES) SHALL BE AVAILABLE.

The above limited warranty does not apply (a) to damage resulting from accident, alteration, misuse, or abuse; (b) if the equipment's serial number is removed or defaced; or (c) for lamps and fuses. THE ABOVE LIMITED WARRANTY IS EXPRESSLY IN LIEU OF ALL OTHER WARRANTIES, EXPRESS OR IMPLIED, INCLUDING MERCHANTABILITY AND FITNESS, AND ALL OTHER WARRANTIES ARE EXCLUDED. HENNY PENNY NEITHER ASSUMES NOR AUTHORIZES ANY PERSON TO ASSUME FOR IT ANY OTHER OBLIGATION OR LIABILITY.

Revised 01/01/07.



Henny Penny Corporation
P.O. Box 60
Eaton, OH 45320

1-937-456-8400
1-937-456-8402 Fax

Toll free in USA
1-800-417-8417
1-800-417-8434 Fax

www.hennypenny.com

Manufactured by:
MKN Maschinenfabrik
Wolfenbüttel, Germany